

PUZZLES 2022



ATHESIA
UNTERNEHMENSGRUPPE

Inhalt / Content

Seite / Page

- 10 **Art Lab Puzzles**
- 12 Home – Norman O’Flynn
- 14 Cool Cattle – Fredi Gertsch
- 16 Timekeeper – Norman O’Flynn
- 18 Pixorama – eBoy
- 24 Jolly Pets – Dean Russo
- 33 Zozoville
- 36 People
- 40 Dreaming – Jeremiah Ketner
- 42 Free Colours – Lora Zombie
- 44 Movie Masters – Alexandre Clérisse
- 46 Bike Art
- Pens are my Friends – Jon Burgerman

- Photo Art Puzzles**
- 48 Edition Alexander von Humboldt
- 62 Magic Forests
- 65 Power of Nature

- Fine Art Puzzles**
- 66 Metamorphosis – André Sanchez
- 68 Floral Friends – Mia Charro
- 70 Exotic Garden – Marie Amalia Bartolini
- 72 Felted Art – Moy Mackay
- 74 Precious Animals – Bob Coonts
- 76 Rosina Wachtmeister
- 82 Map Art

- Fantasy Puzzles**
- 94 Fauna Fantasies – André Sanchez
- 96 Companions – Dimitra Milan
- 98 Pixie Dust – Ilona Reny
- 100 Inner Mystic – Andy Kehoe
- 103 Favole – Victoria Francés
- 104 Forgotten – Cris Ortega
- 106 Enigma Trees – Andy Thomas

- Cartoon Puzzles**
- 108 Funky Zoo – Marino Degano
- 114 Mishmash – Alex Bennett
- 118 Romantic Town – Michael Ryba
- 119 Paradise – Michael Ryba
- 120 Idyll – Mordillo
- 121 Cartoon Classics

- Dreieckspuzzles/Triangular**
- 130 1000 Teile / Pieces
- 144 1500 Teile / Pieces
- 154 2000 Teile / Pieces
- 162 4000 Teile / Pieces

- 168 **Zubehör / Accessories**
- 169 Display
- 170 Technische Angaben / Technical Information
- 172 Register / Index

HEYE PUZZLE NEWS 2022



Das Cover zeigt das Motiv des Puzzles 29969 Inner Mystic, Cosmic Dust © 2021 Andy Kehoe /
The cover shows the design of the puzzle 29969 Inner Mystic, Cosmic Dust © 2021 Andy Kehoe

HEYE'S BEST



Marino Degano

Der Cartoon-Künstler Marino Degano ist in vielen Kulturen zu Hause. Geboren in Italien, aufgewachsen in Deutschland und derzeit in Frankreich ansässig, ist er mit den Macken, Ecken und Kanten der europäischen Bevölkerung vertraut und scheut sich nicht im Geringsten, diese in seinen charmant-ironischen Meisterwerken aufs Korn zu nehmen.

The cartoonist Marino Degano is familiar with many cultures. He was born in Italy, grew up in Germany and currently lives in France, so he is well acquainted with the little idiosyncrasies, corners and edges of European people and does not shy away from using this as the core of his charming ironic masterpieces.

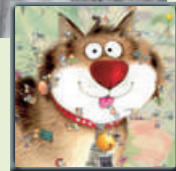

Jean-Jacques Loup

Der französische Künstler Jean-Jacques Loup war studierter Architekt, was sich besonders am unübertroffenen genialen Bildaufbau seiner herausragenden Puzzle-Motive bemerkbar macht. Bei der augenzwinkernden Darstellung drastischer Details schreckte er vor keiner nackten Tatsache zurück, blieb aber trotz aller Schonungslosigkeit immer entwaffnend witzig. Jean-Jacques Loup starb 2015.

The French artist Jean-Jacques Loup majored as an architect. This is immediately obvious in his ingenious puzzle motifs. Loup doesn't flinch from taboos in his eye-catching displays, but in spite of this bluntness, he always remains disarmingly funny. Jean-Jacques Loup passed away in 2015.

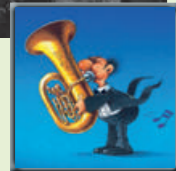

Zozoville

Die Berliner Galerie Zozoville, betrieben vom amerikanischen Künstler Mateo Dineen und dem niederländischen Künstler Johan Potma, ist eine fantastische Welt voller skurriler Geschöpfe. Sie tummeln sich auf alten Holztüren, Schildern und Kisten und laden ein zu lustvollem Abtauchen in aufregende Szenerien und spannende Bildergeschichten.

The Berlin Zozoville Gallery, run by the American artist Mateo Dineen and the Dutch artist Johan Potma, is a fantasy world full of bizarre creatures. They cavort on old wooden doors, signs and boxes and invite you to delve with delight into exciting sceneries and thrilling illustrated stories.

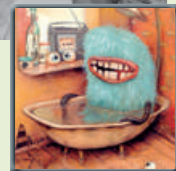

Dean Russo

Der amerikanische Künstler Dean Russo verwendet zur Herstellung seiner knallbunten Tierporträts mindestens zehn verschiedene Techniken. Er benutzt Pastellkreiden, Tinte, Buntstifte, Acryl- und Sprühfarben, macht aber auch Collagen. Seine einzigartigen Bilder zeugen von großer Tierliebe und unterstützen sein Engagement für den Tierschutz.

The American artist Dean Russo uses a minimum of ten mediums per painting for his brightly coloured animal portraits, including pastels, ink, acrylic and spray paint, but also pencils and collage. His truly unique artwork shows his love of animals and supports his commitment to animal protection.

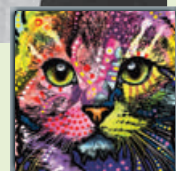

HEYE'S ARTISTS

Art Lab



Jon Burgerman

Der englische Künstler Jon Burgerman hat Schule, College und Uni durchlaufen, um danach zu beschließen, keinen Job zu suchen, sondern Künstler zu werden. Da seine farbintensiven „Gute-Laune-Doodles“ sofort viele Fans und Käufer fanden, darunter Apple, New York Times, Samsung, Instagram und The Victoria and Albert Museum, hat das auch geklappt.

The English artist Jon Burgerman has a school, college and university education, but he decided not to search for a job. Instead he became an artist. The colour intensive good mood doodles immediately attracted a large following of fans and customers. He worked with Apple, New York Times, Samsung, Instagram and The Victoria and Albert Museum.



Norman O'Flynn

Der südafrikanische Künstler Norman O'Flynn hat ein tiefes Verständnis und eine Liebe für die Pop-Art-Tradition und erforscht, was dieses Genre heute bedeutet. Er bezieht sich auf Themen, die im letzten Jahrzehnt relevant geworden sind, und drückt sie in einer visuellen Sprache aus, die in Konzeption, Stil und Technik unverwechselbar ist.

The South African artist Norman O'Flynn has a deep understanding of and love for the pop art tradition and explores what this genre means today. He refers to topics that have become relevant in the last decade and expresses it in a visual language, that is distinctive in conception, style and painting technique.

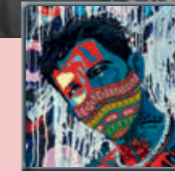

Johnny Cheuk

Der Künstler Johnny Cheuk aus Hongkong experimentiert mit einem spannenden Mix aus traditionellen und hochmodernen Materialien und Techniken, um plakative Bilder im ganz eigenen Stil zu kreieren. Seine farbstarke Arbeiten, unter anderem auch diverse CD-Cover, wurden in zahlreichen Magazinen und Büchern, auf Websites und Ausstellungen veröffentlicht.

The Hong Kong artist Johnny Cheuk experiments with an exciting mix of traditional and state-of-the-art materials and techniques in order to create poster-like images in a very personal style. His colour-intensive creations, among which are also several CD covers, were published in numerous magazines and books, on websites and at exhibitions.



Fredi Gertsch

Der Schweizer Künstler Fredi Gertsch malt unter dem Label „Im Fisch geboren, zur Kuh gefunden“ farbenfrohe Pop Art für humorvolle Menschen. Seine Kühe sind auf der ganzen Welt daheim: Von Bern bis Paris, Los Angeles und New York schmücken sie Ferienhäuser, Appartements, Büros, Arztpraxen – und zaubern ein Lächeln auf jedes Gesicht.

The Swiss artist Fredi Gertsch paints colourful pop art for humorous people under the label „Born under the star sign of Pisces, found his way to the cows“. His cows are at home all over the world: from Bern to Paris, Los Angeles and New York, they decorate holiday homes, flats, offices, doctors' surgeries – and bring a smile to every face.

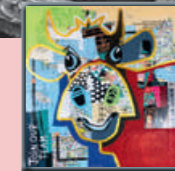

Alexandre Clérissé

Der französische Künstler Alexandre Clérissé ist Autor mehrerer preisgekrönter Comic-Bücher. Eines seiner Lieblingsthemen ist die Kinowelt: Für große Regisseure hat er Wimmelbilder aus deren berühmtesten Filmszenen gestaltet und darin nicht nur viele Hauptfiguren, sondern auch die Filmemacher selbst versteckt. Ein exquisiter Rate-, Such- und Puzzle-Spaß!

The French artist Alexandre Clérissé is the author of several award-winning comic books. The world of cinema is one of his favourite subjects: he has created "seek and find" pictures on great directors, reproducing the most famous scenes of their films by representing the main characters, but also by hiding the directors themselves in the sets. What a pleasure to guess, to look for and to assemble a puzzle!



Jeremiah Ketner

Der amerikanische Künstler Jeremiah Ketner ist ein Märchenwelten-Gestalter. Seine vielfarbigen Landschaften werden bevölkert von nachdenklich-verträumten jungen Frauen und wunderlichen Fabelwesen. Inspirationsquellen seines einzigartigen und mittlerweile international bekannten Stils sind Art nouveau sowie japanische Ästhetik und Zeichentrick.

The American artist Jeremiah Ketner paints a world to which fairytales belong. His paintings often depict richly coloured environments inhabited by a cast of pensive, dreamy young women and whimsical sprites. Renowned throughout the US and internationally, Ketner attributes his influence to Art nouveau, Japanese Aesthetics and Anime.

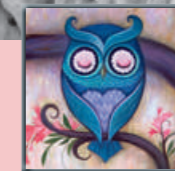

eBoy

Die Künstlergemeinschaft eBoy aus Berlin und Los Angeles hat sich spezialisiert auf sehr coole und komplexe Pixel-Kunst, insbesondere isometrische Stadtansichten. Darin lassen sich jede Menge typische Charaktere und Sehenswürdigkeiten finden. Ein kolossaler Rate-, Such- und Puzzle-Spaß in 1000 Teilen und Millionen von Pixels!

eBoy, the artist group from Berlin and Los Angeles has specialised itself in cool and complex pixel art – more specifically, in isometric city views – which depicts all sorts of characters and places of interest. The artworks offer a multitude of fun riddles, puzzles and hidden details to search for in 1,000 pieces and millions of pixels!



Holli May Thomas

Die amerikanische Künstlerin Holli May Thomas verwendet upgecycelte Materialien, Fundstücke, Papier und viel leuchtende Farbe in ihren energiegeladenen Mixed-Media-Collagen. Sie bezeichnet sich selbst als „hoffnungslose Optimistin, die mit Farbe (und ein wenig Klebstoff) bedeckt ist“, und ist Mitglied der Houston Art Society.

The American artist Holli May Thomas uses upcycled materials, found objects, paper and paint in her colourful and energized mixed media assemblages. She describes herself as a "hopeless optimist covered in paint (and a little adhesive)" and is a member of the Houston Art Society.



HEYE'S ARTISTS

Art Lab / Fine Art

HEYE'S ARTISTS

Fine Art / Fantasy



VOKA

Der österreichische Künstler VOKA vermittelt traditionelle, in der Kunst gültige Werte in einer neuen, dem Zeitgeist entsprechenden Interpretation. Seinen unverwechselbaren Malstil, der sich aus der Dynamik des Augenblickes entwickelt, nennt er „Spontanrealismus“. Seine farbstarken Bilder finden sich weltweit in Sammlungen, Ausstellungen und Kunstauktionen.

The Austrian artist VOKA reinterprets traditional values valid in the art world to reflect the zeitgeist. He calls his unique painting style "spontaneous realism", which develops out of the dynamics of any given moment. His colourful images can be found in collections, exhibitions and art auctions around the world.

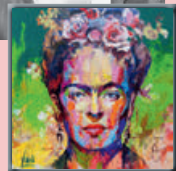

Bob Coonts

Der amerikanische Künstler Bob Coonts startete nach über 30 erfolgreichen Jahren als Grafikdesigner eine zweite Karriere als Maler und Bildhauer. Er lebt mit seiner Frau Sallie an einem See mit herrlichem Blick auf die Rocky Mountains, die ihm immer wieder eine wunderbare Quelle der Inspiration für seine stimmungsvollen und dekorativen Bilder sind.

The American artist Bob Coonts started a second career as a painter and sculptor after more than 30 successful years as a graphic designer. He lives with his wife Sallie by a lake with a wonderful view of the Rocky Mountains, which are a constant source of inspiration for his atmospheric and decorative images.

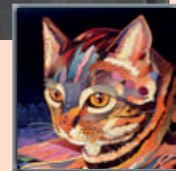

Rajko Zigic

Der kroatische Künstler Rajko Zigic hat sich auf detaillierte Landkarten spezialisiert. Seine Inspiration holt er sich bei antiken kartografischen Werken und alten Geschichten über Schatzkarten, Eroberer und Entdecker. Sein Ziel ist es, geografische Informationen so ansprechend darzustellen, dass man auf jeden Fall einen zweiten Blick darauf wirft.

Croatian artist Rajko Zigic has made highly detailed maps his artistic specialty. He is drawing his inspiration from ancient cartographic works and old stories about treasure maps, conquerors and explorers. His aim is to present geographical information in such an appealing way as to get everyone excited about giving it a second glance.

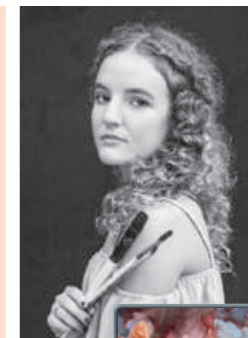
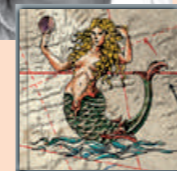

Dimitra Milan

Die amerikanische Künstlerin Dimitra Milan wurde in eine Familie etablierter Künstlerinnen und Künstler hineingeboren und hat ihren Stil und ihr Können schon in sehr jungen Jahren entwickelt. Ihre Bilder spiegeln eine verträumte Welt wider, in der alles möglich ist und furchtlose Charaktere harmonisch nebeneinander existieren.

The American artist Dimitra Milan was born into a family of established artists and has been developing her style and ability from a very young age. Her paintings reflect a dreamy world where anything is possible and fearless subjects harmoniously coexist.

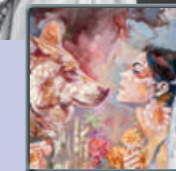

Lora Zombie

Die russische Künstlerin Lora Zombie gehört in der Urban Art Scene zu den Topsellern. Mit ihren einzigartigen Kommentaren zur Popkultur und dem scharfen Auge für Schönheit ist ihr Stil unverkennbar. Sie hat bereits eine große Fangemeinde auf der ganzen Welt und stellt in namhaften Galerien in New York, Los Angeles, Toronto, London und St. Petersburg aus.

The Russian artist Lora Zombie is a top seller on the urban art scene. With a unique commentary on pop culture and a keen eye for beauty, her style is unmistakable. She has already gained a massive following of fans across the globe and held major exhibitions in New York, Los Angeles, Toronto, London and Saint Petersburg.

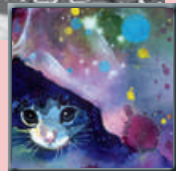

Sara Drake

Die australische Künstlerin Sara Drake bestreitet ihren Lebensunterhalt mit der Kombination ihrer wahren Leidenschaften – Reisen, Bildhauerei, Malerei und 3D-Illustration. Sie entwirft und produziert aufwendig gebastelte und individuelle Weltkarten bzw. Globen für internationale Kunden. Zum Glück auch für Heye-Puzzles!

The Australian artist Sara Drake makes a living by combining her true passions – travel, sculpting, painting and 3D illustration. She designs and produces intricately crafted and customised world maps or globes for international clients. Fortunately also for Heye puzzles!

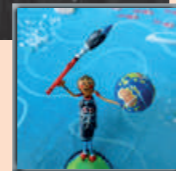

André Sanchez

Der französische Künstler André Sanchez vermischt virtuos bestehende Elemente, um etwas Neues zu kreieren. Als Autodidakt hat er längere Zeit viel fotografiert und sich so eine eigene Bilddatenbank als Basis aufgebaut. Mittlerweile arbeitet er professionell für Kunden wie Sony Music, die FIFA und diverse Magazine oder ist in Ausstellungen in ganz Europa zu sehen.

The French artist André Sanchez virtuously mixes existing elements to create something new. As an autodidact, he photographed a lot for a long time and built up his own image databank as a basis. He now works professionally for clients such as Sony Music, FIFA and various magazines and can be seen in exhibitions throughout Europe.

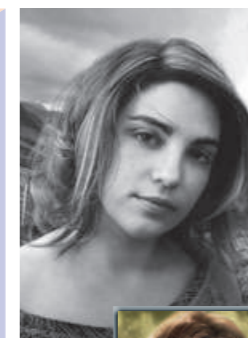
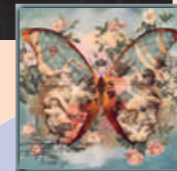

Cris Ortega

Die spanische Künstlerin Cris Ortega gestaltet nach dem Besuch der Kunstschule in Valladolid und der Arbeit in einer Werbeagentur Comics und Illustrationen für diverse Zeitschriften, Fanzines und Bücher. Ihre eigene Buchreihe „Forgotten“ beinhaltet ihre besten Werke und verzaubert durch tiefgründige Schönheit und atmosphärische Dichte.

The Spanish artist Cris Ortega has designed comics and illustrations for various magazines, fanzines and books after visiting the art school in Valladolid and working in an advertising agency. Her own book series "Forgotten" includes her best works and enchants with its profound beauty and atmospheric density.

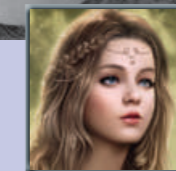

Marie Amalia Bartolini

Die französische Künstlerin Marie Amalia Bartolini kam als Tochter einer Unterglasmalerin und eines Bildhauers früh in Kontakt mit Kunst. Ihre eigene Arbeit bietet eine großartige Realitätsflucht aus dem Erwachsenen in eine kindliche Wahrnehmung der Welt, die bei ihr voller Farben und Wunder und von friedlich miteinander lebenden Tieren bevölkert ist.

The French artist Marie Amalia Bartolini came into early contact with art as the daughter of an under glass painter and a sculptor. Her own work offers a magnificent escape from reality from adulthood into a childlike perception of the world, which in her case is full of colours and wonders and populated by animals living peacefully together.

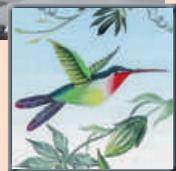

Moy Mackay

Die schottische Künstlerin und Absolventin der Glasgow School of Art Moy Mackay verwendet den Werkstoff Filz, um daraus faszinierende Textildrucke zu gestalten. Ihre Werke begeistern durch überragende Technik, Kompositionskunst und Farbtiefe. In ihrer Galerie in den Scottish Borders bietet sie ihre Originale, Bücher und sogar weltweite Schulungen an.

The Scottish artist and Glasgow School of Art graduate Moy Mackay uses felt as a medium to create fascinating textural paintings. Demonstrating outstanding techniques, compositional skills and depth of colour, her work is truly inspired. In addition to her original work, Mackay has written several books and teaches her unique art form worldwide as well as from her own gallery in the beautiful Scottish Borders.

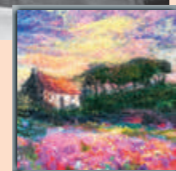

Victoria Francés

Die spanische Künstlerin und Autorin Victoria Francés entführt in eine spannungreiche Welt voller Romantik, Mystik und Leidenschaft. Dabei wagt sie faszinierende Blicke auf das Dunkle, Magische und Gefährliche, das bei ihr immer aufregend und verführerisch wirkt. Und genau so scheint sie auch selbst zu sein ...

The Spanish artist and author Victoria Francés transports viewers into an exciting world full of romance, mystery and passion. In her paintings she dares to take a fascinating look into the dark, the magical and the dangerous, which always produces an exciting and enticing effect. She also appears to match this description in person ...

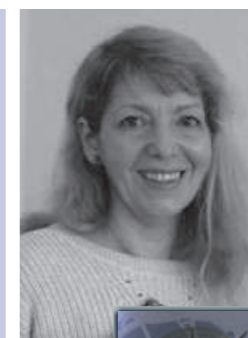
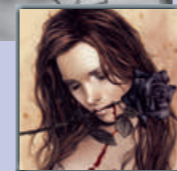

Ilona Reny

Die deutsche Künstlerin Ilona Reny füllt ihre verspielten Traumwelten mit allerlei surrealen Wesen, Pflanzen und Dingen. Sowohl in ihren Büchern, Groß- und Postkarten als auch in ihren Puzzles ergeben sich immer wieder spannende und anregende Szenen, die mit vielen liebevollen Details und einzigartigem Design eine zauberhafte Stimmung erzeugen.

The German artist Ilona Reny fills her playful dream world with all kinds of surreal creatures, plants and objects. Her books, greeting cards and postcards – as well as her puzzles – repeatedly incorporate exciting and spectacular scenes, which create a magical mood through loving details and unique designs.

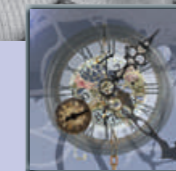

Mia Charro

Die spanische Künstlerin Mia Charro hat den Anspruch, aus jeder ihrer Illustrationen ein kleines Samen Korn zu machen, aus dem eine positive Lebenseinstellung und der Glaube an das eigene Können wachsen. Ihre stilischeren und charmanten Bildkompositionen zeigen ihre Liebe für das Magische, das Ungewöhnliche, das Unerwartete.

The Spanish artist Mia Charro has the ambition to turn each of her illustrations into a small seed from which a positive attitude towards life and the belief in one's own abilities can grow. Her stylistically confident and charming picture compositions show her love for the magic, the unusual, the unexpected.



Rosina Wachtmeister

Die erfolgreiche Künstlerin Rosina Wachtmeister ist besonders bekannt für ihre fantasievollen und farbenfrohen Katzendarstellungen. Ihre Bilder sind märchenhaft poetische Liebeserklärungen an den Süden und besonders Italien, wo sie zusammen mit vielen Katzen und anderen Tieren in inspirierender Idylle wohnt.

The successful artist Rosina Wachtmeister is known particularly for her imaginative and colourful paintings of cats. Her pictures are poetic, fairytale declarations of love for the South, in particular Italy, where she lives in an inspiring idyll together with her many cats and other animals.

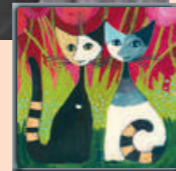

Andy Kehoe

Der amerikanische Künstler Andy Kehoe kreiert faszinierend mystische Szenen. Er zeigt wundersame Charaktere in Augenblicken ätherischer Magie und spiritueller Abenteuer. Mit seinem großen Verständnis für Emotionen, seinem geschickten Umgang mit Licht und seiner außergewöhnlichen Maltechnik macht er seine Bilder zu poetischen Erzählungen.

The American artist Andy Kehoe creates intriguing mystic scenes. He shows miraculous characters in moments of ethereal magic and spiritual adventure. With his great understanding of emotions, his deft handling of light and his extraordinary techniques he turns his pictures into poetic narratives.

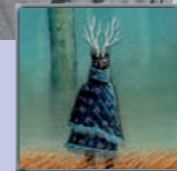

Andy Thomas

Der australische Künstler Andy Thomas hat eine außergewöhnliche und kulturbedingte Bildsprache entwickelt, inspiriert von der Vielfalt und Schönheit einiger der ältesten Regenwälder der Erde. Er kombiniert Digital Art und Wasserfarben und symbolisiert zukunftsweisend das Aufeinandertreffen von Natur und Technologie.

The Australian artist Andy Thomas has developed an iconic visual language that is uniquely his own, inspired by the beauty of some of the world's most ancient rain forests. Using a combination of digital art and water colours, his work is a symbolic representation of nature's collision with technology.

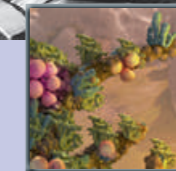

HEYE'S ARTISTS

Cartoon



Mattias Adolfssohn

DE Der schwedische Künstler Mattias Adolfssohn hat seine Tätigkeit als freier Illustrator über einige Umwege gefunden: Sein Interesse für Mathematik führte zu einem Maschinenbau-Studium, weiter ging es mit Architektur und Grafikdesign. Nach einer Zeit als Entwickler von Computerspiel-Animationen wechselte er von 3D zu 2D und ist seither preisgekrönter Buchautor.

EN The Swedish artist Mattias Adolfssohn came to be a freelance illustrator via several detours: His love for mathematics led to a degree in mechanical engineering, followed by degrees in architecture and graphic design. After a stint as a developer of computer game animations, he switched from 3D to 2D and became an award-winning book author.



Doro Göbel & Peter Knorr

DE Das deutsche Künstlerpaar Doro Göbel und Peter Knorr lernte sich beim Kunststudium in Mainz kennen und lebt in Nierstein am Rhein. Die beiden sind seit vielen Jahren Autoren preisgekrönter Bilder- und Wimmelbücher, die sich mit vielen kleinen Geschichten inklusive diverser Rätsel und Suchspiele bei allen Altersklassen großer Beliebtheit erfreuen.

EN The German artist couple Doro Göbel and Peter Knorr met during their time at Arts University in Mainz and now lives in Nierstein/Rhine valley. They both are authors of award-winning picture and wimmelpicture books that delight readers of all ages with their many little stories and various little riddles and search tasks.

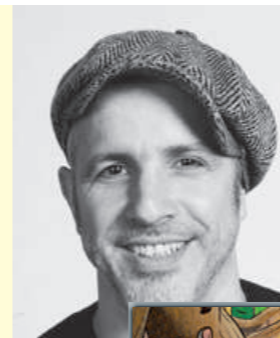

Uli Oesterle

DE Der deutsche Künstler Uli Oesterle arbeitet seit seiner Ausbildung an der Akademie für Gestaltung in München als freier Grafiker, Illustrator und Comicautor. Als solcher hat er seine Werke in diversen Büchern veröffentlicht, in Ausstellungen gezeigt und einige Preise dafür gewonnen. Beste Grundlagen also für herausragende Puzzlecartoonkunst!

EN The German artist Uli Oesterle worked as a freelancer, illustrator and author of comics since his education at the Academy for Design in Munich. He published his arts in diverse books, displayed them in exhibitions and won several prizes. Best fundamentals for distinguished puzzle cartoon art!

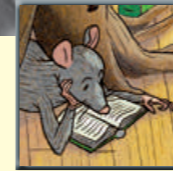

Christoph Schöne

DE Der deutsche Künstler Christoph Schöne ist als Mitbegründer, Vorstand und Redakteur des Comicpools Comicaze e.V. fester Bestandteil der Münchner Zeichner-Szene. Er ist zwar gelernter Florist, arbeitet heute jedoch als selbstständiger Illustrator. Wimmelbilder liebt er, weil man unzählige kleine witzige Geschichten in einem einzigen Motiv erzählen kann.

EN As co-founder, chair and editor of the comicpool Comicaze e.V., the German artist Christoph Schöne is one of the prominent figures of Munich's illustrator scene. He is a trained florist but now works as a freelance illustrator. He adores wimmelpictures because they allow him to tell countless funny little stories in one sole image.



Alex Bennett

DE Der englische Künstler Alex Bennett hat sich nach einigen Wimmelbildern zum Thema Sport darangemacht, die Geschichte der englischen Musik (inklusive einiger Beiträge aus Irland) in einem sensationell detailreichen Gesamtkunstwerk festzuhalten. Über 800 Stunden hat die Fertigstellung gedauert, und jetzt findet jeder Musikliebhaber darin alles, was das Herz begehrt.

EN Following his series of sports-themed puzzle books, the English artist Alex Bennett has set about depicting the history of English music (also with various contributions from Ireland) in a sensationally detailed work of art. It took over 800 hours to complete and now encompasses illustrations for every music lover to enjoy to their heart's content.

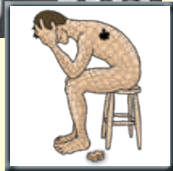

Anders Lyon

DE Der schwedische Künstler Anders Lyon war einige Zeit lang Architekt, bevor er erkannt hat, wo seine eigentliche Berufung liegt. Jetzt arbeitet er als freier Illustrator unter dem Motto „Vereinfachen, verdeutlichen, begeistern“. Das gelingt ihm bei seinen Bildern wunderbar: Sie sind ganz einfach gut, eindeutig wimmelig und die Puzzler sind begeistert!

EN The Swedish artist Anders Lyon was an architect for some time before realizing his true calling. He is now working as a freelance illustrator, staying true to his motto to „simplify, clarify, inspire“. His pictures are ample testimony to his success: They are simply great, quite lively and busy, and an absolute thrill for puzzlers!

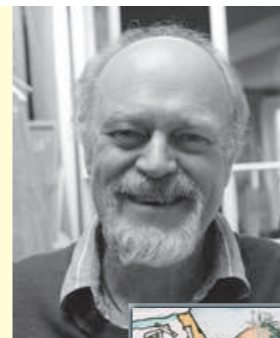

Korky Paul

DE Der in Simbabwe geborene Künstler Korky Paul ist ein sehr erfolgreicher Kinderbuch-Illustrator. Besonders bekannt ist seine millionenfach verkaufte Bilderbuch-Serie „Zilly und Zingaro“. Seine Werke erkennt man an seinen herrlich anarchischen, unkonventionellen und doch detailliert und fein gearbeiteten Szenen und Figuren. Mittlerweile lebt er in Oxford/England und in Griechenland.

EN The Zimbabwean-born artist Korky Paul is a very successful children's book illustrator, best known for the multi-million selling „Winnie and Wilbur“ series of picture books. His works can be recognised by his wonderfully anarchic, unconventional yet detailed and finely crafted scenes and figures. He divides his time between Oxford (England) and Greece.

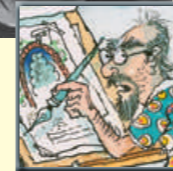

Birgit Tanck

DE Die deutsche Künstlerin Birgit Tanck arbeitet nach Grafikdesign-Studium und Werbeagentur-Jobs als selbstständige Illustratorin und Cartoonistin. Als echtes Nordlicht beschäftigt sie sich viel mit Hafen, Fluss und Meer, kennt sich aber auch mit dem Süden aus: Ihre Zeichnungen erschienen sowohl im „Hamburger Abendblatt“ als auch in der „Süddeutschen Zeitung“.

EN Following her studies in graphic design and jobs in advertising companies, the German artist Birgit Tanck now works as a freelance illustrator and cartoonist. A real northerner, she often focuses on harbours, rivers and the sea, but she also knows the South: Her drawings are published in „Hamburger Abendblatt“ as well as in the national newspaper „Süddeutsche Zeitung“.

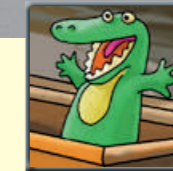

Rita Berman

DE Die in Moldawien geborene Künstlerin Rita Berman hat ursprünglich Architektur studiert, ist mittlerweile aber freischaffende Designerin und Illustratorin. Sie lebt derzeit in Frankfurt am Main, wo sie märchenhafte, verspielte und reich bevölkerte Fantasiewelten in lebhaften Farben „baut“, aus denen dann wunderbar vielfältige und -teilige Puzzles werden.

EN The artist Rita Berman, who was born in Moldavia, initially studied architecture and now works as a freelance designer and illustrator. She is currently living in Frankfurt am Main, where she „builds“ magical, playful and well-populated fantasy worlds in lively colours that eventually become delightfully varied and challenging puzzles.



Florian Mitgutsch

DE Der deutsche Künstler Florian Mitgutsch, Sohn des Kinderbuchautors Ali Mitgutsch, hat früh eine Leidenschaft für das Zeichnen und Malen entwickelt. Nach seiner Zeit als Graffiti-Sprayer, Comiczeichner und einem Studium für Kommunikationsdesign arbeitet er als freier Illustrator – und mit zunehmender Begeisterung auch an Wimmelbildern!

EN The German artist Florian Mitgutsch, son of the children's book author Ali Mitgutsch, developed a passion for drawing and painting at an early age. After his time as a graffiti sprayer, comic artist and studying communication design, he works as a freelance illustrator – and with increasing enthusiasm also on busy pictures puzzles!



Hugo Prades

DE Der spanische Künstler Hugo Prades gehört in seinem Heimatland zur ersten Garde der Comic-Macher. Er hat schon als Zwölfjähriger eigene Geschichten geschrieben und wurde nach einer Architekturausbildung ein gefragter Illustrator. Besonders gerne widmet er sich in seinen Werken heißen Massenpartys, die vor Ausgelassenheit nur so sprühen.

EN In his homeland, the Spanish artist Hugo Prades is in the vanguard of comic artists. He began writing his own stories, when he was just twelve years old, becoming a sought-after illustrator after completing his studies in architecture. He enjoys dedicating himself to painting images of high-spirited festivities and celebrations.



Marija Tiurina

DE Die litauische Künstlerin Marija Tiurina beherrscht ganz unterschiedliche Gestaltungsstile und hat für viele bekannte Firmen gearbeitet. Ihre Projekte reichen von Werbung und Charakterdesign bis hin zu Kinderbüchern und Spielen. Im Moment macht es ihr vor allem Spaß, komplexe Kompositionen voll spielerischer Details für Puzzles zu bauen.

EN The Lithuanian artist Marija Tiurina has mastered a wide variety of design styles and has worked for many well-known companies. Her projects range from advertising and character design to children's books and games. At the moment she especially enjoys building complex compositions full of playful details for puzzles.

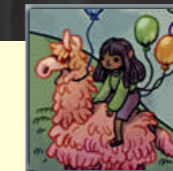

Roger Blachon

DE Der französische Künstler Roger Blachon ist immer noch einer der bekanntesten Cartoonisten seines Landes. Er veröffentlichte seine Werke in diversen Zeitschriften, illustrierte aber auch Kinderbücher. Seine Vielseitigkeit zeigt sich u. a. darin, dass er sowohl den „Grand Prix de L'Humour Blanc“ als auch den „Grand Prix de L'Humour Noir“ gewonnen hat. Roger Blachon starb 2008.

EN The French artist Roger Blachon is still one of the most famous cartoonists in his country. He published his works in diverse magazines, but also illustrated children's books. His diversity is best shown, among other things, in the fact that he won both the „grand prize for white humour“ and the „grand prize for black humour“. Roger Blachon passed away in 2008.

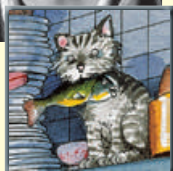

Guillermo Mordillo

DE Der argentinische Künstler Guillermo Mordillo war einer der ganz Großen seines Faches. Er schuf die unverwechselbaren und umwerfend sympathischen Knollennasemännchen, die ihn und seine Cartoons rund um die Welt berühmt machten. Sie bringen einen immer wieder zum Schmunzeln, Staunen, Träumen und Nachdenken, und das ganz ohne Worte. Guillermo Mordillo starb 2019.

EN The Argentinian artist Guillermo Mordillo was one of the big fishes in his field. He created the irreplaceable and extremely likeable pug-nosed little men, which have made him and his cartoons famous all over the world. They make you grin, gape, dream and think again and again, without using any words. Guillermo Mordillo passed away in 2019.

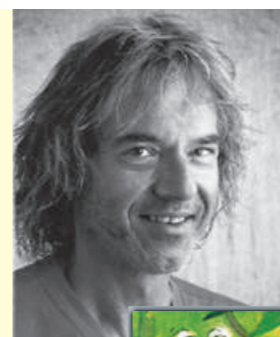
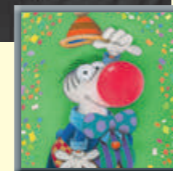

Michael Ryba

DE Der deutsche Künstler Michael Ryba lernte u. a. beim berühmten Joseph Beuys, bevor er sich im tiefen Schwarzwald niederließ und begann, seine monumentalen Meistercartoons in Puzzleform zu bringen. Seine lebenswerten Illustrationen finden sich aber auch in zahlreichen Büchern, Ausstellungen und Sonderprojekten, z. B. bei der Gestaltung einer Schule. Michael Ryba starb 2014.

EN The German artist Michael Ryba studied with the famous Joseph Beuys, before he established himself deep in the Black Forest and began to put his monumental master cartoons into puzzle form. His loveable illustrations can also be found in numerous books, exhibitions and special projects, for example the design of a school. Michael Ryba passed away in 2014.



Simon Tofield

DE Der englische Künstler Simon Tofield ist ein sehr erfolgreicher Animator, der mit fünf Katzen zusammenlebt. Schon als Junge entwickelte er beim Basteln kleiner Daumenkinos eine Leidenschaft fürs Zeichnen und Animieren. Seine bekannteste Kreation ist Simon's Cat, eine Online-Animationsserie, die allein auf YouTube mehr als 1 Milliarde Views hat.

EN The English artist Simon Tofield is a very successful animator who lives with his five cats. His passion for drawing started when as a young boy, he learned to animate by creating imaginative flipbooks. Simon's most well-known creation is Simon's Cat, an online animated series that has amassed over 1 billion views on YouTube alone.



Home



- Spannende und detailreiche Wohlfühlräume
- Voller farbstarker Lieblingsstücke
- Norman O'Flynn's zweite Puzzle-Serie



- Exciting and detailed feel-good rooms
- Full of colourful favourites
- Norman O'Flynn's second puzzle series

HOME NORMAN O'FLYNN



NEW

29973 Home, Room With Deer



1000



NEW

29974 Home, Room With Wave



1000



Fredi Gertsch

- Seine Lieblingstiere: „Kuhle“ Kühe
- Diese farbenfrohen Rindviecher sind und machen glücklich!
- Und sie sind weltweit beliebte Sammelobjekte

- His favourite animals: cool cows
- These colourful cattle are and make happy!
- And they are popular collectors' items worldwide

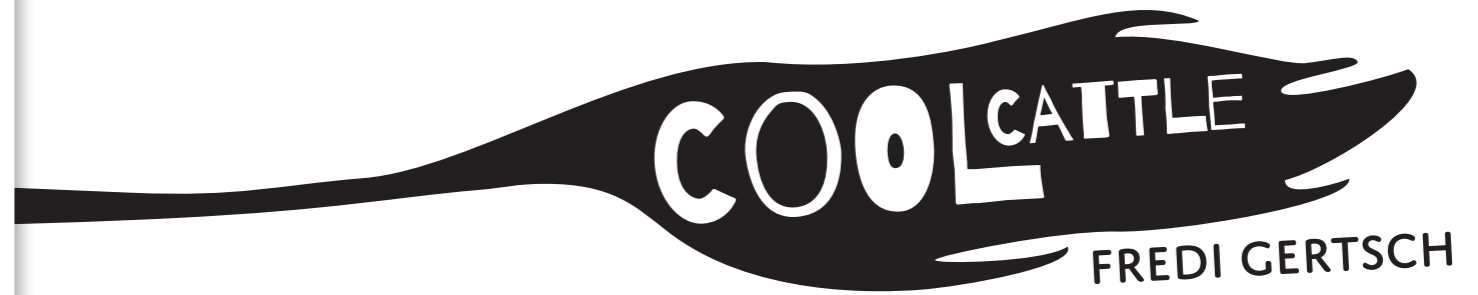

NEW

29985 Cool Cattle, Dotted Cow
 1000
 4 001689 299859

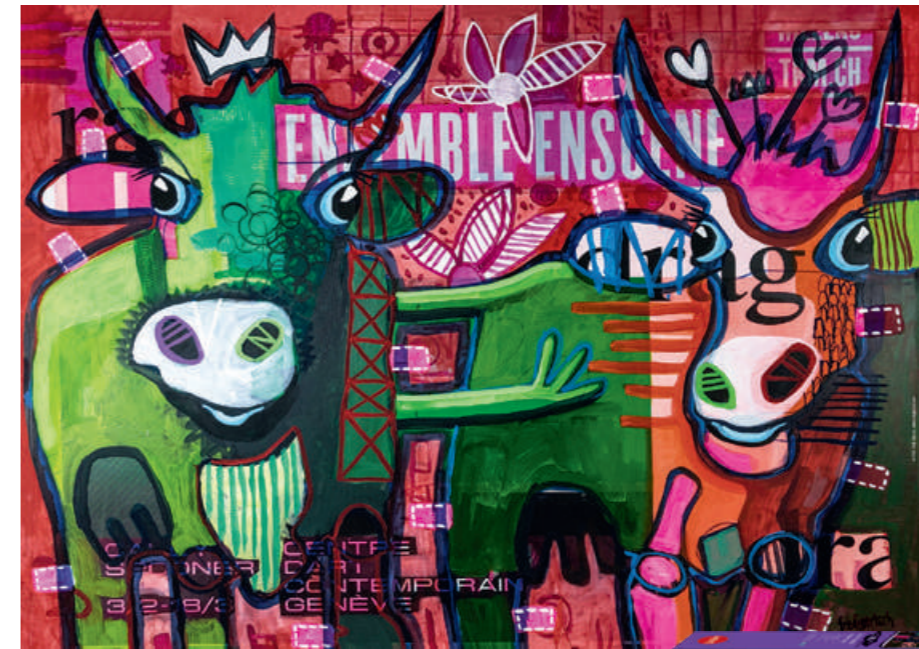

NEW

29984 Cool Cattle, Striped Cows
 1000
 4 001689 299842



TIMEKEEPER

Norman O'Flynn



29941 Timekeeper,
Be the Sunrise

1000



4 001689 299415

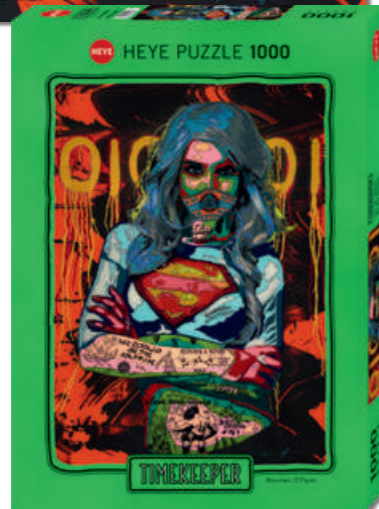

29942 Timekeeper,
Sharing is Caring

1000



4 001689 299422



29975 Timekeeper,
I Know You Can

1000



4 001689 299750



Norman O'Flynn

-  Maler und Bildhauer aus Südafrika
- Genauer Beobachter relevanter Gesellschaftsthemen
- Unverwechselbare Bildsprache in Pop-Art-Tradition

-  Painter and sculptor from South Africa
- Precise observer of relevant social issues
- Unique visual language in Pop Art tradition

NEW



Pixorama

- | | |
|--|--|
| <ul style="list-style-type: none"> ■ Puzzles mit Rate- und Suchspiel ■ Beliebte Städte mit bekannten Sehenswürdigkeiten und Charakteren ■ eBoy: Künstlergemeinschaft mit Kultstatus | <ul style="list-style-type: none"> ■ Puzzles with seek and find game ■ Popular cities with well-known sights and characters ■ eBoy: artist community with cult status |
|--|--|



29914 Pixorama, New York Quest

1000

Bestseller



NEW

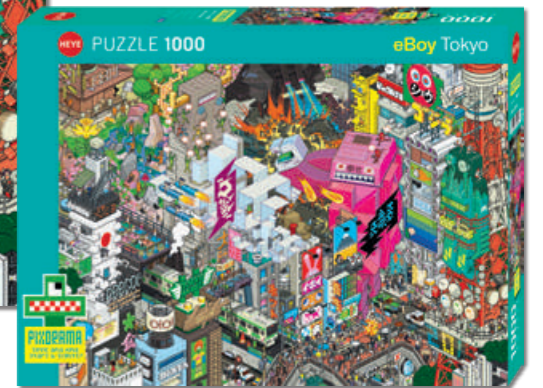

29981 Pixorama, Tokyo Quest

1000



29915 Pixorama, Berlin Quest

1000



29935 Pixorama, London Quest

1000



Dean Russo

- | | |
|--|---|
| <ul style="list-style-type: none"> ■  US-Künstler, der in farbenprächtigen Werken seine Lieblingstiere porträtiert ■ Verwendet viele verschiedene Techniken: Pastellkreide, Sprühfarben, Collagen u. v. m. ■ Spendet viele seiner Bilder diversen Tierschutzorganisationen | <ul style="list-style-type: none"> ■  US artist who portrays his favourite animals in colourful and vibrant works of art ■ Applies a lot of different techniques: pastel chalk, spray colours, collages etc. ■ Donates many of his paintings to various animal protection organisations |
|--|---|



NEW

NEW

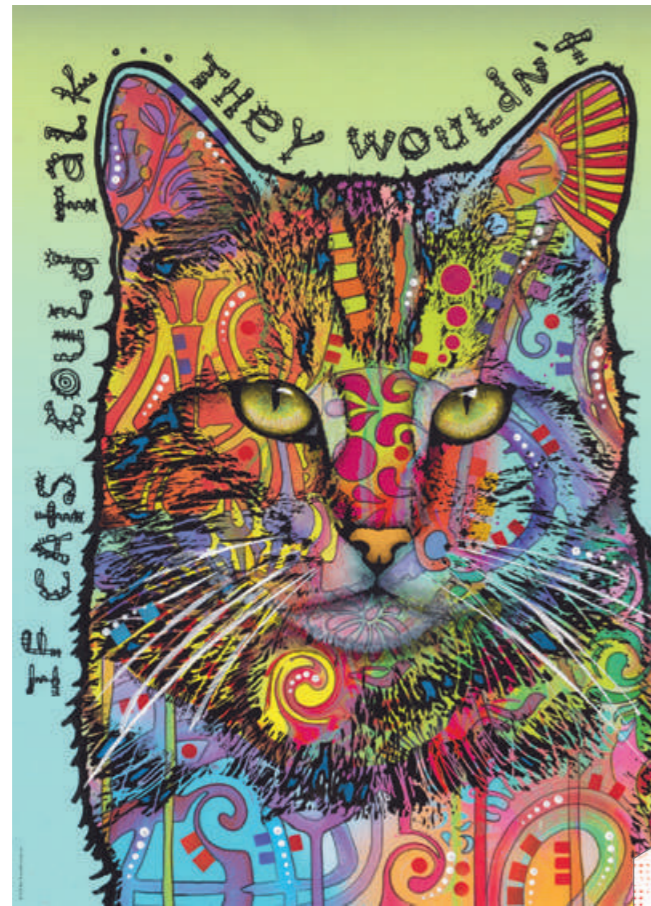

29893 Jolly Pets, If Cats Could Talk

 1000



29965 Jolly Pets, Love Relentlessly

 1000



29964 Jolly Pets, My Cat Can Purr

 500



Achtung! Warning!
Erstickungsgefahr wegen verschluckbarer Kleinteile.
Choking hazard because of small parts.



29809 Jolly Pets, Wolf's Soul

1000



29766 Jolly Pets, Wild Tiger

1000



Bestseller



29732 Jolly Pets, Dogs Never Lie

1000



Bestseller



29731 Jolly Pets, 9 Lives

1000



Bestseller





29864 Jolly Pets, Devoted 2 Cats

1000



29937 Jolly Pets, Donkey Love

1000



Bestseller

29810 Jolly Pets, Abyssinian

2000



Bestseller

29894 Jolly Pets, Lion's Heart

2000



Zozoville

-



NEW

NEW



NEW



29968 Zozoville, Off Broadway
 2000



29967 Zozoville, Omnivore
 1000



29966 Zozoville, Jarantine
 1000





29701 Zozoville, Milk Tooth

500



4 001689 297015

Bestseller



29675 Zozoville, Sit!

500



4 001689 296759

Bestseller



29897 Zozoville, Selfie

1000



4 001689 298975

Bestseller



29898 Zozoville, Veggie

1000



4 001689 298982

Bestseller



Achtung! Warning! Erstickungsgefahr wegen verschluckbarer Kleinteile. Choking hazard because of small parts.



29865 Zozoville, Laundry Day

1000



4 001689 298654

Bestseller



29866 Zozoville, Monsta Hi!

1000



4 001689 298661

Bestseller



29811 Zozoville, Spring Time

1000



4 001689 298111



29812 Zozoville, Neighbourhood

1000



4 001689 298128





29896 Zozoville, Banjo

1000



29539 Zozoville, Bathtub

1000



Bestseller



Jubiläum Anniversary



29743 Zozoville, Red Balloon

1000



Bestseller



29742 Zozoville, Carrot

1000



Bestseller





29938 Zozoville, Road Trippin'

2000



4 001689 299385



People



- Plakative und farbstarke Werke
- Bekannte Motive berühmter Stars
- Veröffentlicht in Büchern, Zeitschriften, Ausstellungen und Websites



- Striking, colourful works
- Well-known motifs of famous stars
- Published in books, magazines, at exhibitions and on websites



29867 Cheuk, Audrey II

2000



4 001689 298678





29710 Cheuk, Marilyn

1000



4 001689 297107



29684 Cheuk, Audrey

1000



4 001689 296841

Bestseller



29912 VOKA, Frida

1000



4 001689 299125

Bestseller

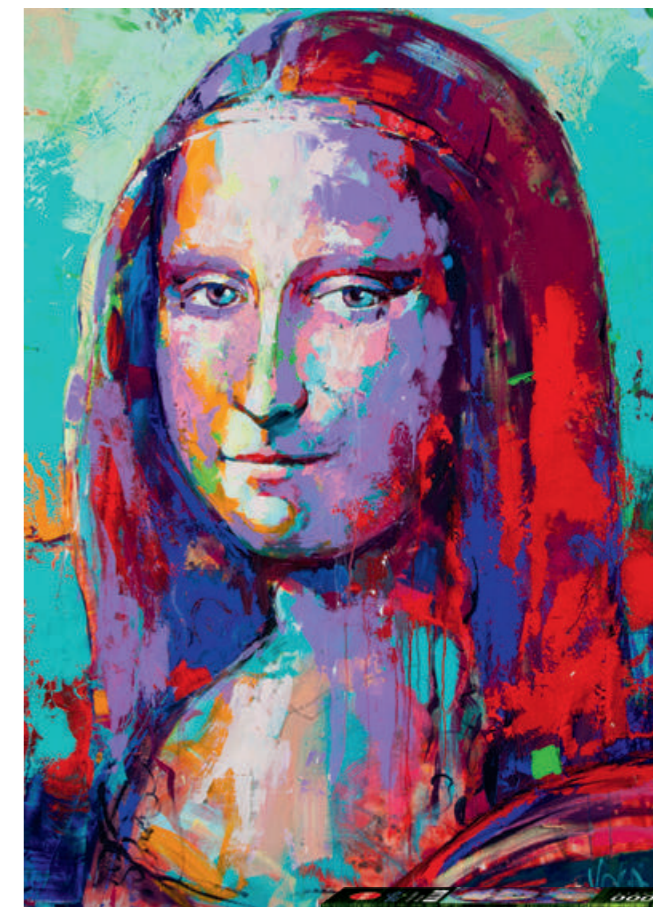

29948 VOKA, Mona Lisa

1000



4 001689 299484





Jeremiah Ketner



- Populäre Farbwelt mit verträumten Mädchen und (Fabel-)Wesen
- Inspiriert von Art Nouveau sowie japanischer Ästhetik und Zeichentrick
- Große Fangemeinde durch diverse Internet- und Social-Media-Aktivitäten



- Popular colour world with day-dreaming girls and mythical creatures
- Inspired by Art Nouveau as well as Japanese aesthetics and cartoons
- Large international fan community due to various internet and social media activities

Jeremiah Ketner
Dreaming

NEW



29849 Dreaming, Better Tomorrow

1000



29687 Dreaming, Black Kitty

1000



29955 Dreaming, Kitty Cats

1000



29976 Dreaming, Crystal Fox

500



Achtung! Warning! Erstickungsgefahr wegen verschluckbarer Kleinteile. Choking hazard because of small parts.



29895 Dreaming, Strawberry Kitty



1000



29803 Dreaming, Panda Naps

1000



29686 Dreaming, Wishing Tree

1000



29768 Dreaming, Great Big Owl

1000





29907 Free Colours, Mini Unicorn



1000



Lora Zombie



- Junge Autodidaktin aus Russland
- Topseller in der urbanen Kunstszene
- Einzelausstellungen in großen Städten wie New York, London oder St. Petersburg



- Young autodidact from Russia
- Top seller in the urban art scene
- Solo exhibitions in major cities such as New York, London or St. Petersburg



29825 Free Colours, Meow



1000



29851 Free Colours, Universe Creator



1000



29883 Movie Masters, Steven Spielberg Films



 1000

MOVIE MASTERS

ALEXANDRE CLÉRISSE

Movie Masters

- | | |
|---|---|
| <p></p> <ul style="list-style-type: none"> ■ Puzzles mit spannendem Rate- und Suchspiel! ■ Große Regisseure und ihre berühmtesten Filme in einem Wimmelbild ■ Alexandre Clérisse ist ein international erfolgreicher Comicbuchautor | <p></p> <ul style="list-style-type: none"> ■ Puzzles with exciting seek and find game ■ Renowned directors and their most famous films in a hidden-object scene ■ Alexandre Clérisse is an internationally successful comic book author |
|---|---|

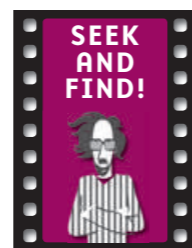

29882 Movie Masters, Tim Burton Films



 1000

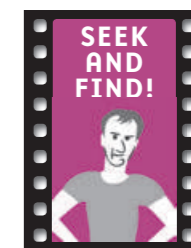

29949 Movie Masters, Tarantino Films



 1000



29541 Lempert, Freedom Deluxe

1000



10

Jubiläum Anniversary



BIKE ART. BICYCLES IN ART AROUND THE WORLD

Bike Art



- Radfahren wird immer beliebter
- Stylish-bunte Bilder rund um das Trendthema
- Verschiedene Künstler und Stile



- Cycling becomes more and more popular
- Stylish and colourful images of the trend theme
- Different artists and styles



29737 Lempert, Colourful Row

1000



29950 Thomas, Momentum

1000



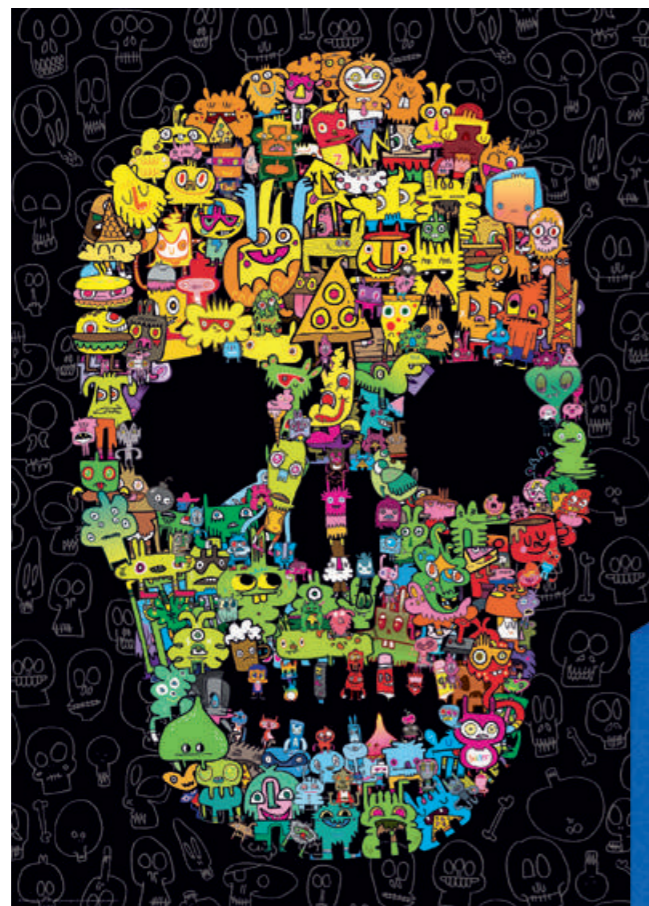

29850 Burgerman, Doodle Skull



1000



29786 Burgerman, Doodle Rainbow



1000



Jon Burgerman Pens are my Friends

Jon Burgerman



- Farbintensive „Gute-Laune-Doodles“
- Junge, freche und stylish-bunte Welt
- Bekannt durch internationale Werbekampagnen und Ausstellungen



- Colour-intensive good-mood-doodles
- Young, cheeky and stylishly vibrant world
- Popularised through international advertising campaigns and exhibitions



29936 Burgerman, Doodle Village

1000





Edition Alexander von Humboldt



- Puzzle-Bestseller
- Beeindruckende Natur- und Tiermotive
- Fotografiert von namhaften Künstlern



- A jigsaw bestseller
- Stunning images of nature and animals
- Photographed by prominent artists

EDITION ALEXANDER VON HUMBOLDT



29712 Mountain Stream



1000



NEW



29977 Sheep and Volcanoes



1000



29769 Seljalandsfoss Waterfall



1000



29945 Arrow Dynamic



1000

PHOTO ART PUZZLES



29594 Mesa Arch



1000



29815 Guanacos



1000



29856 Red Mangrove



1000



29903 Tatoosh Mountains



2000

Bestseller





NEW



29470 Stingray

1000



29978 Sheryang-ji Lake

1000



PHOTO ART PUZZLES

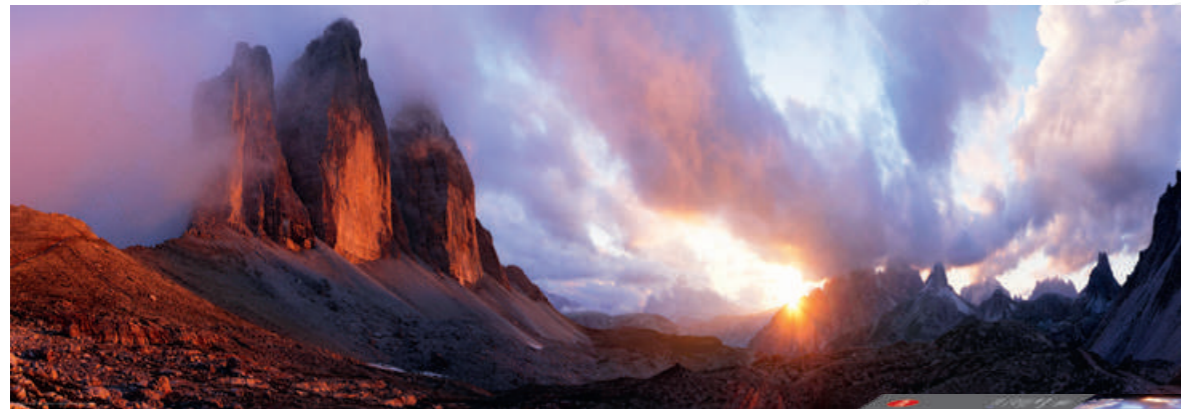

29770 3 Peaks

1000



29946 Iceland Horses

1000





29286 Lighthouse Le Créac'h

1000



29606 Milford Sound

1000

Bestseller



PHOTO ART PUZZLES



29287 Elephant

1000

Bestseller



29859 Zen Reflection

1000

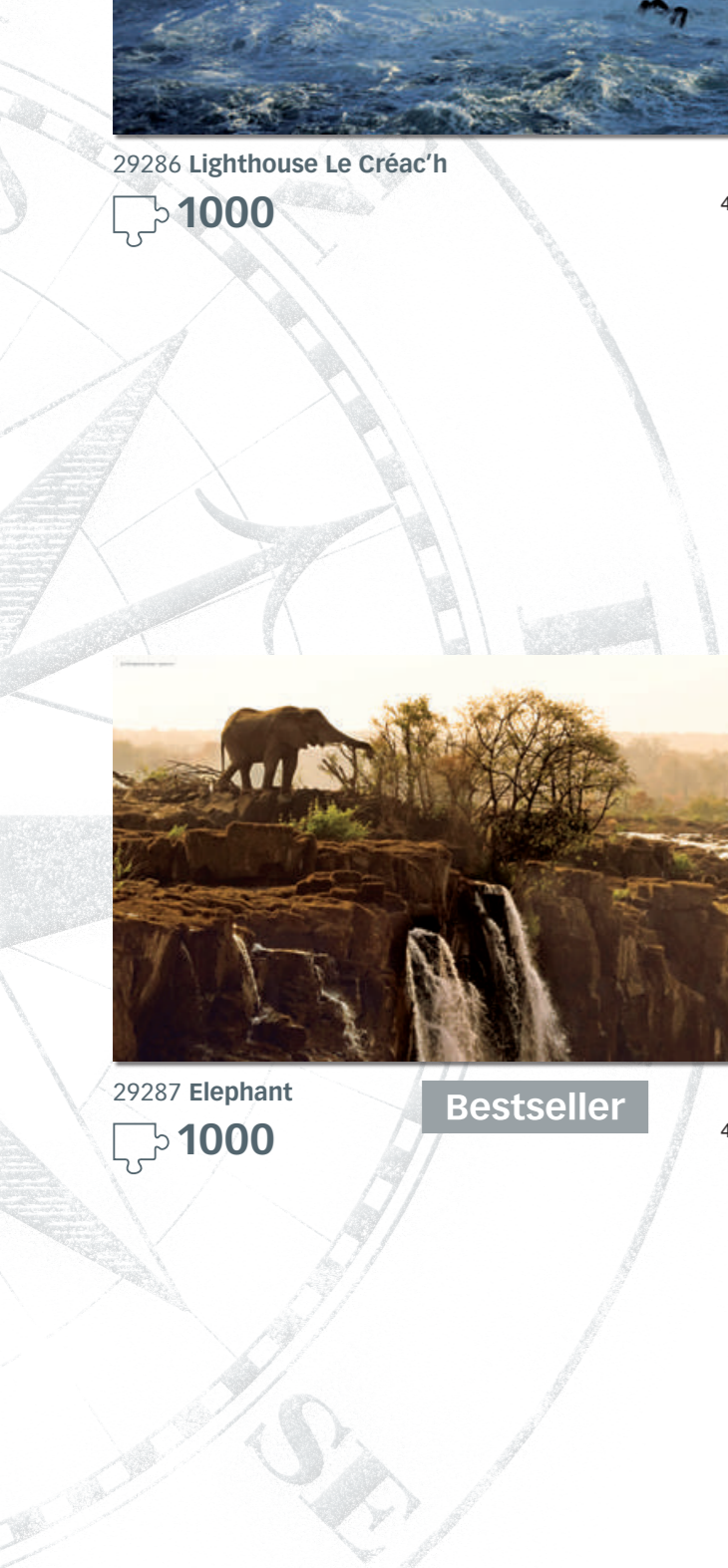



29902 Lake Tekapo

1000

Bestseller



29901 Play of Light

1000

Bestseller



29399 Divi Divi Tree

1000



29816 Wharariki Beach

1000

Bestseller



PHOTO ART PUZZLES



29947 Morning Salute

1000



29715 Blue Lake

1000

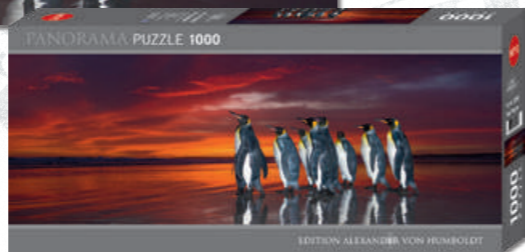

PHOTO ART PUZZLES



29858 King Penguins

1000



29857 Polar Light

1000





29608 Red Dawn

2000



Bestseller



29860 Paradise Palms

2000



Bestseller



PHOTO ART PUZZLES



29508 Herd of Elephants

2000

10
Jubiläum
Anniversary



Bestseller



29472 Oak Tree

2000



Bestseller





29602 Magic Forests, Cascades



1000



29855 Magic Forests, Guiding Light



1000

Magic Forests

Magic Forests

- Mystische Wälder

■ Fotografien im magischen Licht

■ Bilder mit geheimnisvoller Atmosphäre
- Mystic woodland

■ Photographs with magical light

■ Images with a mysterious vibe



29943 Magic Forests, Rainbow Road

1000





29906 Magic Forests, Calla Clearing

1000

Bestseller



29805 Magic Forests, Stags

1000

Bestseller



POWER OF NATURE

Power of Nature

- Die Kraft der vier Elemente Feuer, Wasser, Erde und Luft
- Energiegeladene Momentaufnahmen
- Spektakuläre Naturschauspiele

- The power of the four elements fire, water, earth and air
- Energetic snapshots
- Sensational natural spectacles



29549 Power of Nature, Northern Lights

1000



Bestseller



29944 Power of Nature, Singing Canyon

1000



PHOTO ART PUZZLES



André Sanchez



- Autodidaktischer Fotograf und Illustrator
- Mixt virtuos verschiedenste Bildelemente
- Arbeitet für Magazine und große Kunden wie Sony oder die FIFA



- Self-taught photographer and illustrator
- Mixes a wide variety of visual elements with virtuosity
- Works for magazines and major clients such as Sony or FIFA



NEW



NEW

29971 Metamorphosis, Wings No. 1



1000



29972 Metamorphosis, Wings No. 2



1000



FINE ART PUZZLES



Mia Charro

- Stilsichere Illustratorin aus Spanien
- Macht Designs für viele Trendprodukte
- Herzerwärmende und freundliche Motive

- Stylish illustrator from Spain
- Designer of many trend products
- Heartwarming and friendly motifs



NEW



29953 Floral Friends, Sweet Squirrel

1000



29954 Floral Friends, Cuddly Panda

1000



29952 Floral Friends, Funny Hedgehog

500



29970 Floral Friends, Gentle Bruin

1000



FINE ART PUZZLES

Achtung! Warning! Erstickungsgefahr wegen verschluckbarer Kleinteile. Choking hazard because of small parts.



EXOTIC GARDEN

MARIE AMALIA BARTOLINI



29956 Exotic Garden, Plant Paradise

500



29957 Exotic Garden, Bird Paradise

1000



29958 Exotic Garden, Wildlife Paradise

2000



Marie Amalia Bartolini

- Künstlerin mit einzigartiger Unterglas-Technik
- Inspiriert von Märchen, Legenden, Mythologie und Bibelstoff
- Wunderbare Motive zur entspannenden Realitätsflucht

- Artist with unique under glass technique
- Inspired by fairy tales, legends, mythology and bible material
- Wonderful motifs for a relaxing escape from reality

Achtung! Warning! Erstickungsgefahr wegen verschluckbarer Kleinteile. Choking hazard because of small parts.

FINE ART PUZZLES

Moy Mackay



- Schottische Künstlerin mit eigener Galerie und Onlineshop
- Ihre Kunstwerke beeindrucken mit der Vielfaltigkeit von Filz
- Weltweite Workshops und bereits drei veröffentlichte Bücher



- Scottish artist with her own gallery and online shop
- Her artworks impress with the diversity of felt
- Worldwide workshops and already three published books

FELTED ART

Moy Mackay



29917 Felted Art, Sundown Poppies



1000



29916 Felted Art, Washing Line



1000





Bob Coonts



- Bekannt für farbenfrohe Kunstwerke
- Naturalismus mit abstrakten Elementen
- Inspiriert von der beeindruckenden Natur der Rocky Mountains



- Known for colourful artwork
- Naturalism with abstract elements
- Inspired by the stunning nature of the Rocky Mountains



29879 Precious Animals, Ever Alert

1000



29878 Precious Animals, So Cosy

1000



PRECIOUS ANIMALS by Bob Coonts



29939 Precious Animals, Night Wolf



1000

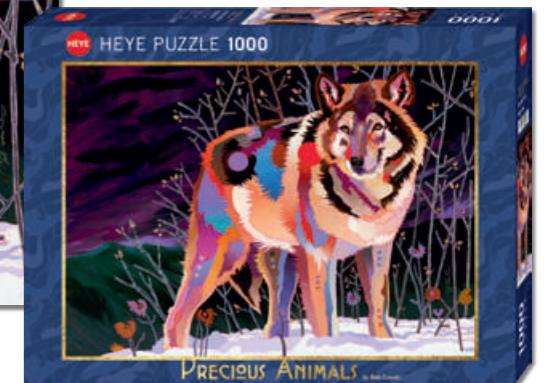

29899 Precious Animals, Take a Break





1000





Rosina Wachtmeister

- | | |
|--|--|
| <p></p> <ul style="list-style-type: none"> ■ Beliebte zeitgenössische Künstlerin ■ Große und treue Fangemeinde ■ Sehr erfolgreiches Thema für Produkte aller Art | <p></p> <ul style="list-style-type: none"> ■ Popular contemporary artist ■ Big number of followers ■ Very successful theme for all sorts of products |
|--|--|

Rosina Wachtmeister



Mit Goldfolienprägung
 With gold foil stamping



29854 Wachtmeister, Gold Rain
Mit Goldfolienprägung / With gold foil stamping

 1000



29900 Wachtmeister, Poppy Canopy
Mit Goldfolienprägung / With gold foil stamping

 1000



Mit Goldfolienprägung
With gold foil stamping



29616 Wachtmeister, Flowerbed
Mit Goldfolienprägung / With gold foil stamping

1000



29853 Wachtmeister, Yellow Ribbon
Mit Goldfolienprägung / With gold foil stamping



1000



FINE ART PUZZLES



29818 Wachtmeister, Sleep Well!
Mit Goldfolienprägung / With gold foil stamping



1000





Mit Goldfolienprägung
With gold foil stamping



29158 Wachtmeister, Sun
Mit Goldfolienprägung /
With gold foil stamping

1000



29819 Wachtmeister, Lilies
Mit Goldfolienprägung /
With gold foil stamping

1000



29721 Wachtmeister, Roses
Mit Goldfolienprägung / With gold foil stamping

2000





29913 PABUKU, Quirky World



2000

Hochwertiges Poster inklusive!
High quality poster included!



29846 Rajko Zigic, Amazing World



2000

MAP ART

Map Art

- Ungewöhnliche Kunstwerke
- Extraordinary works of art
- Aufwendig und detailreich gestaltet
- Elaborately designed and detailed creation
- Verschiedene Illustrationsstile
- Different styles of illustration

Hochwertiges Poster inklusive!
High quality poster included!

FINE ART PUZZLES



29871 Rajko Zigic, Retro World



1000

Bestseller



29847 Rajko Zigic, Pirate World



2000

Hochwertiges Poster inklusive!
High quality poster included!



29666 Rajko Zigic, Vintage World



2000

Hochwertiges Poster inklusive!
High quality poster included!

Bestseller

FINE ART PUZZLES



29797 Rajko Zigic, Satellite Map



2000



29845 Rajko Zigic, The World



2000

Bestseller

Hochwertiges Poster inklusive!
 High quality poster included!



29615 Rajko Zigic, Hemisphere Map

6000

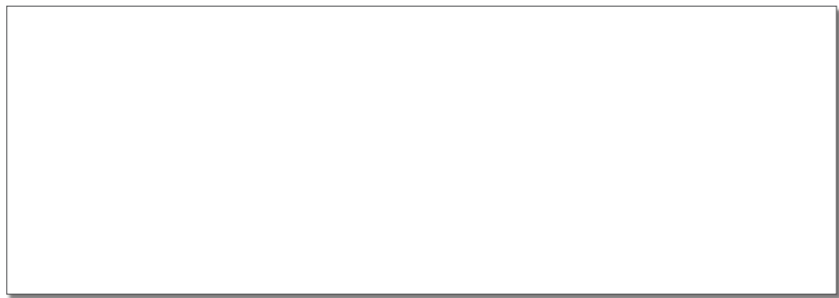

235.6 cm

83.1 cm



FINE ART PUZZLES



- Phänomenale Collage aus handgemachten Mini-Kunstwerken
- Aufwendig gebastelt, bemalt und arrangiert von Sara Drake
- Für spannende Puzzle-Entdeckungsreisen um die ganze Welt



- Phenomenal collage of handmade mini artworks
- Intricately crafted, painted and arranged by Sara Drake
- For exciting puzzle explorations around the world

NEW



29983 Sara Drake, Miniature World

 2000



Hochwertiges Poster inklusive!

High quality poster included!





- Imaginärer Stadtplan zur Darstellung der populären Musikkultur
- Einteilung der Stadtteile in Musikstile
- Die einzelnen Straßen, Plätze und Gebäude sind nach wegweisenden Bands und Musikern benannt
- Kreiert und ausgearbeitet von der Radiosendung „Zündfunk“ auf Bayern 2

- Imaginary city map presenting the popular musical culture
- All important musical styles form a district
- And (musical) neighbourhoods and correlations can be easily recognized



29844 City of Pop
2000



Hochwertiges Poster inklusive!
High quality poster included!

Übersicht der Stadtteile / Overview of districts



- Einzigartige Collage von Matthew Cusick
- Aus alten Weltkarten neu zusammengesetztes Motiv
- Kartografische Sachlichkeit verwandelt sich in Bewegung, Emotion, Kraft



- Unique collage by Matthew Cusick
- Motif reassembled from old world maps
- Cartographic objectivity is transformed into movement, emotion, power

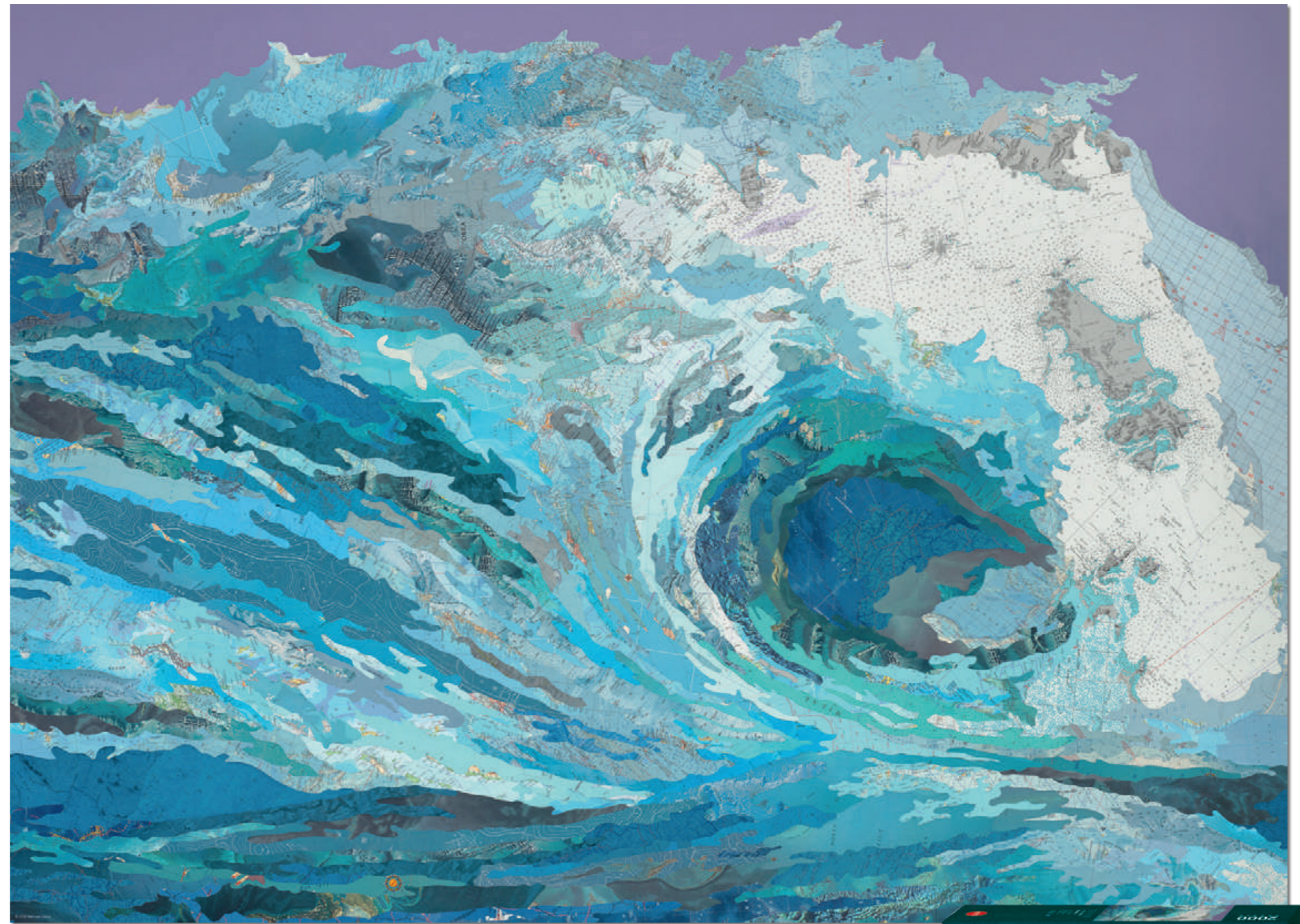

29872 Matthew Cusick, Map Wave

2000

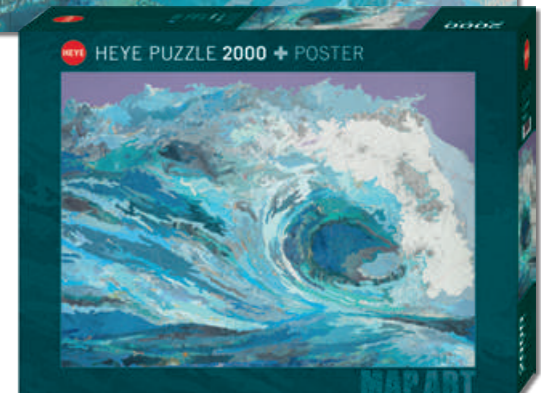

Hochwertiges Poster inklusive!

High quality poster included!

FINE ART PUZZLES

Fauna Fantasies



- Faszinierende Mischwesen in einer Art Garten Eden
- Angesagte Collagen-Technik
- André Sanchez' zweite Puzzle-Serie



- Fascinating mixed creatures in a kind of Garden of Eden
- Trendy collage technique
- André Sanchez's second puzzle series

FAUNA FANTASIES

ANDRÉ SANCHEZ



NEW

29980 Fauna Fantasies,
Equidae



4 001689 299804

1000



NEW

29979 Fauna Fantasies,
Jackalope



4 001689 299798

1000





29959 Companions, Aligned Destiny



1000

Bestseller



29960 Companions, Shared River



1000

Bestseller

COMPANIONS

DIMITRA MILAN

Dimitra Milan



- Junger und begabter Nachwuchs aus Künstler-Familie
- Ihre Träume sind ihre Inspiration
- Große Fangemeinde auf Instagram und Facebook



- Young and talented offspring from an artist family
- Her dreams are her inspiration
- Large fan community on Instagram and Facebook



NEW



29982 Companions, Steadfast Heart



1000



29918 Pixie Dust, Magic Keys



1000

Pixie Dust

ILONA RENY

Ilona Reny

- Kreiert surreale Collagen mit zauberhaft-verträumtem Flair
- Creates surreal collages with enchantingly dreamy flair
- Trendiger Stil mit vielen liebevollen Details
- Trendy style with many loving details
- Eigener Verlag mit Büchern und Postkarten
- Own publisher with books and postcards



29919 Pixie Dust, Fairy Park



1000



29951 Pixie Dust, Pearl Rain



1000



Andy Kehoe

-  Erfindet mystische Welten in außergewöhnlicher Maltechnik
- Große Social-Media-Fangemeinde
- Zeichnet u. a. für die New York Times

-  Invents mystical worlds by using an extraordinary painting technique
- Large social media fan base
- Makes drawings, among others, for the New York Times

Inner Mystic

by Andy Kehoe



29880 Inner Mystic, Worlds Apart

 1000



29881 Inner Mystic, Forest Cathedral

 1000



NEW

29969 Inner Mystic, Cosmic Dust

 1000





29940 Inner Mystic, New Skies

1000



29908 Inner Mystic, Wondrous Journey

1000



Victoria Francés

- Victoria Francés ist eine Gothic-Stilkone
- Weltweit hoher Bekanntheitsgrad
- Bestseller-Thema

- Victoria Francés is a Gothic style icon
- Known around the world
- Absolute bestseller



29198 Favole, Poison

1000



29430 Favole, Dark Rose

1000



Cris Ortega



- Autorin der Buchreihe „Forgotten“
- Äußerst detailreiche Bildkompositionen
- Eigener YouTube-Channel



- Author of the book series “Forgotten”
- Extremely detailed compositions
- Own YouTube channel

Forgotten by Cris Ortega



29614 Ortega,
Gold Jewellery

1000



4 001689 296148



29389 Ortega, Swans

1000



4 001689 293895





Enigma Trees

Andy Thomas



29828 Enigma Trees, Phosphorus Tree

1000



29910 Enigma Trees, Magnesium Tree

1000



Andy Thomas

- Inspiriert von der Schönheit der ältesten Regenwälder der Erde
- Kombiniert in seinen Arbeiten Natur und Technologie
- Hat damit eine ganz eigene, faszinierende Bildsprache entwickelt
- Inspired by the beauty of Earth's oldest rainforests
- Combines nature and technology in his work
- Thus developed his own distinctive, fascinating visual language



29909 Enigma Trees, Strontium Tree

1000





29870 Degano, Australian Habitat

1000

Bestseller





4 001689 298708

FUNKY ZOO

MARINO DEGANO

Marino Degano

-  Seit 30 Jahren äußerst erfolgreich im HEYE Puzzle-Programm
-  Extremely successful in the HEYE Puzzle range for over 30 years
- Die Puzzle-Serie mit lustigen Zoo-Motiven
- Puzzle series with funny zoo designs
- Die Motive passen aneinander, sowohl links als auch rechts
- The motifs match each other on the left and right



29833 Degano, Monkey Habitat

1000

Bestseller



4 001689 298333

Puzzles zum Aneinanderreihen
Puzzles to link



29963 Degano, Transylvanian Habitat

1000



4 001689 299637



Puzzles zum Aneinanderreihen
Puzzles to link



29639 Degano, African Habitat

1000



29692 Degano, Polar Habitat

1000

Bestseller



29727 Degano, Jurassic Habitat

1000



29638 Degano, Black Forest Habitat

1000

Bestseller



CARTOON PUZZLES



Puzzles zum Aneinanderreihen
Puzzles to link



29693 Degano, Nile Habitat

1000



29777 Degano, Ocean Habitat

1000



Bestseller



Alle Motive passen zusammen

All motifs fit together

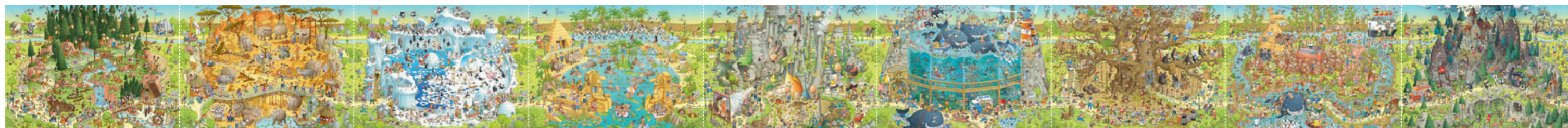

Black Forest Habitat

African Habitat

Polar Habitat

Nile Habitat

Jurassic

Habitat

Ocean Habitat

Monkey Habitat

Australian Habitat

Transylvanian Habitat

MISHMASH

BY ALEX BENNETT

Alex Bennett

- Meister der Such- und Wimmelbilder
 - Tausende von handgezeichneten Figuren
 - Checkliste aller zu findenden Charaktere, Objekte und Ereignisse auf beiliegendem Poster
-
- Master of search and hidden-object scenes
 - Thousands of hand-drawn figures
 - Checklist of all characters, objects and events concerned on the enclosed poster

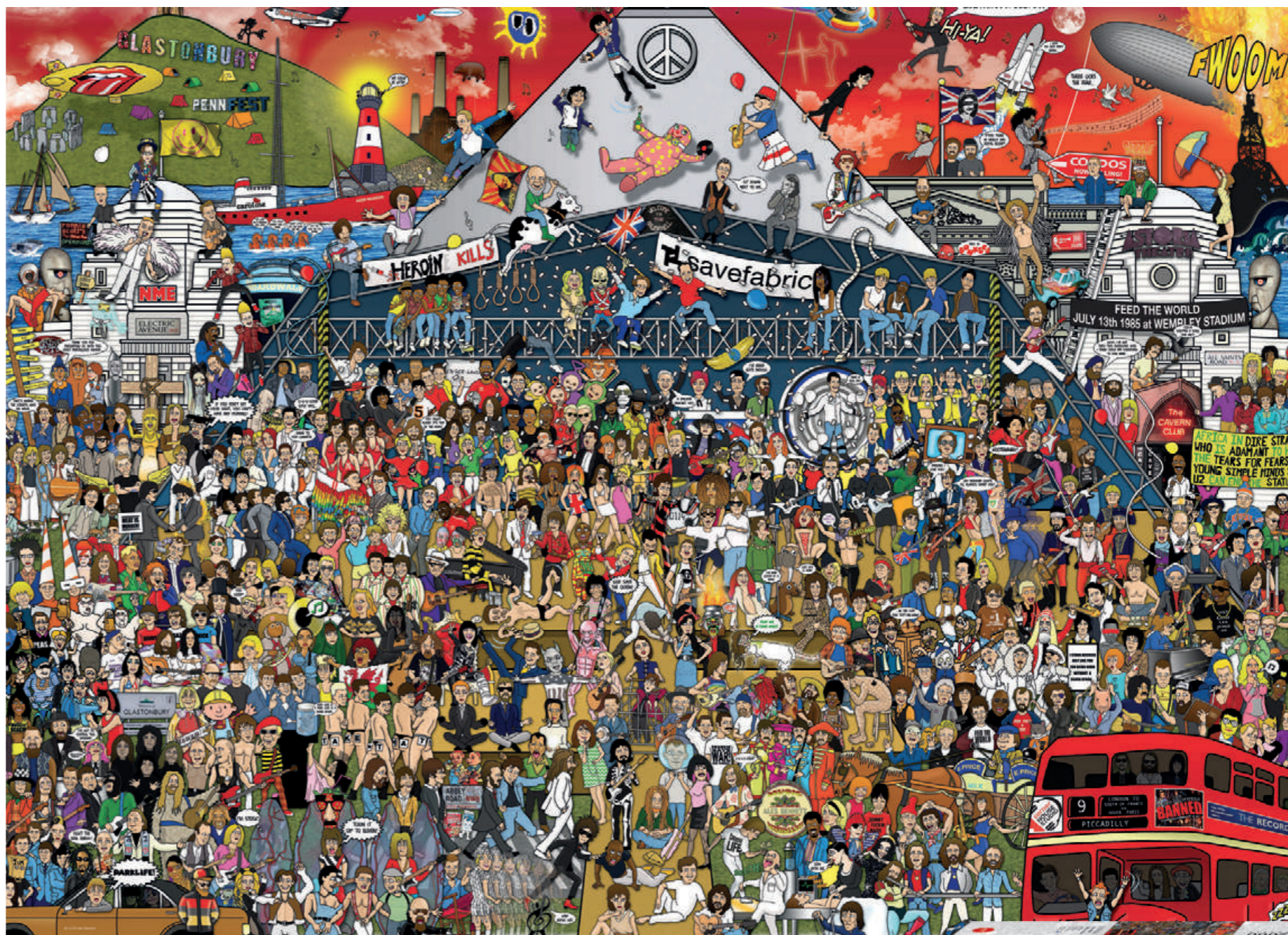

29848 Alex Bennett, British Music History

2000

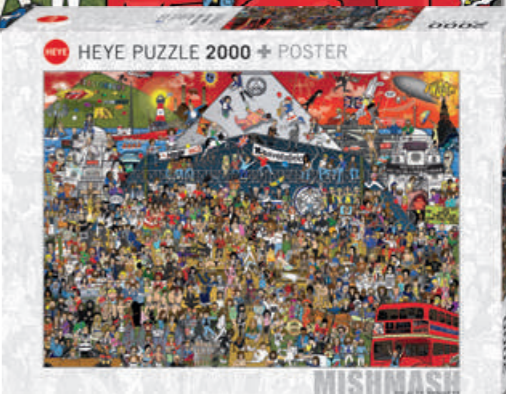

Hochwertiges Poster inklusive!
High quality poster included!

- Die britische Musikgeschichte in einem Bild!
- Mit allen wichtigen Bands und Musikern der Szene!
- Unvergessliche historische und aktuelle Meilensteine!

- The British history of music in one picture!
- With all important bands and musicians of the scene!
- Unforgettable historic and current milestones!



- Die sensationellsten Momente der Fußball-Geschichte in einem Bild!
- Mit unvergesslichen Charakteren, Kultobjekten und Ereignissen!
- Mit den besten Szenen der EM 2020/21



- The most sensational moments of football history – all in one picture!
- With unforgettable characters, cult objects and events!
- With the best scenes of the European Championship 2020/21

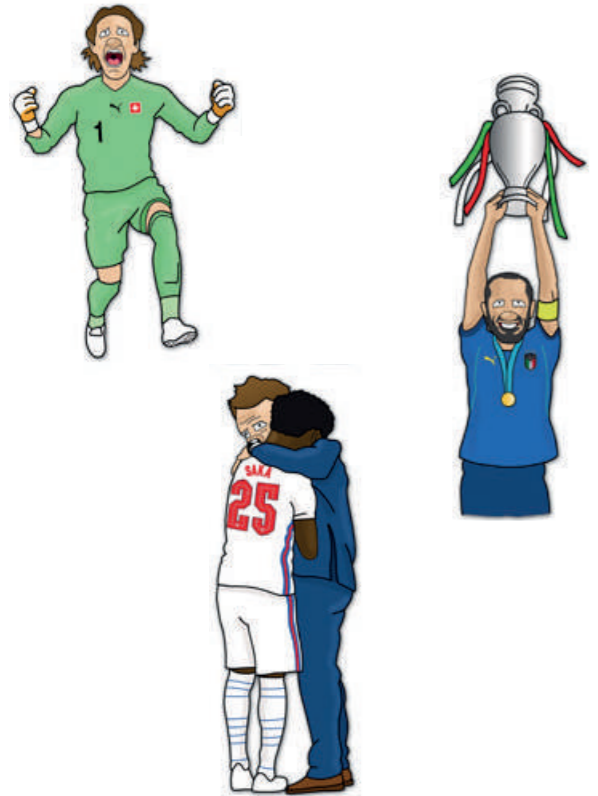

29205-12 Alex Bennett, Football History

3000



Hochwertiges Poster inklusive!

High quality poster included!



CARTOON PUZZLES



Michael Ryba



- Renommierter HEYE-Künstler
- Bestseller-Motive als Puzzle-Zweiteiler
- Aneinandergelegt tolle Gesamtkunstwerke



- Renowned HEYE artist
- Bestseller motifs as puzzle two-piece
- Linked together great works of art



29874 Romantic Town, By Day

1000



4 001689 298746

Bestseller



29875 Romantic Town, By Night

1000



4 001689 298753



29961 Paradise, In Winter

1000



4 001689 299613

29962 Paradise, In Summer

1000



4 001689 299620



CARTOON PUZZLES



Mordillo

- Einer der bedeutendsten Künstler bei Heye
- Hier eines seiner liebenswerten Motive als Puzzle-Zweiteiler
- Aneinandergelegt ergibt sich ein wunderbares Gesamtkunstwerk
- One of the most important artists at Heye
- Here's one of his endearing motifs as a two-part puzzle
- When put together, the result is a wonderful work of art



29986 Idyll, By The Field
1000



NEW

29987 Idyll, By The Lake
1000



NEW

PUZZLES ZUM ANEINANDERLEGEN PUZZLES TO LINK



Cartoon Classics

- Die erfolgreichsten HEYE Top-Cartoonisten
- Die populärsten Wimmelbilder
- Puzzle-Dauerseller
- The most successful HEYE cartoonists
- The most popular cartoons
- Puzzle big seller



29911 Mordillo, Thank You!
500



Achtung! Warning! Erstickungsgefahr wegen verschluckbarer Kleinteile. Choking hazard because of small parts.



29284 Mordillo, Photo

1000



29359 Mordillo, Football

1000



NEW

29988 Loup, Off On Holiday!

500



Achtung! Warning! Erstickungsgefahr wegen verschluckbarer Kleinteile. Choking hazard because of small parts.



NEW

29989 Ryba, Funny Farm

1000



CARTOON PUZZLES



29564 Loup, Score

1000



4 001689 295646

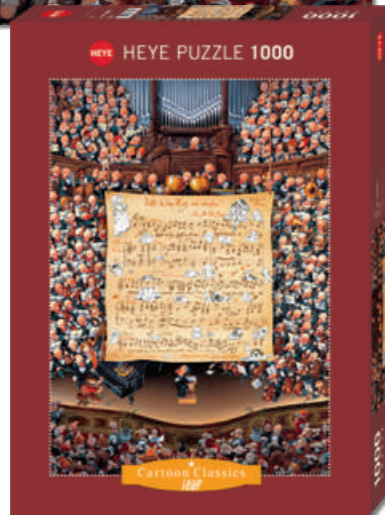

29905 Loup, Vive Notre Dame!

1000



4 001689 299057

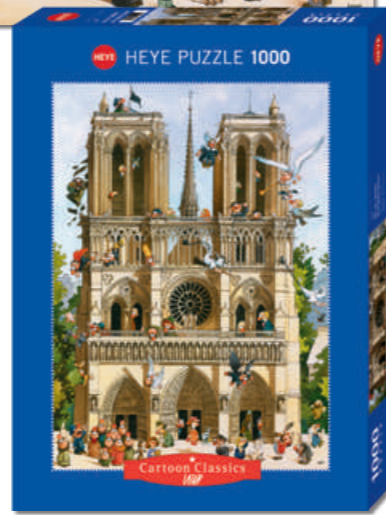

29904 Blachon, Cool Down!

1000



4 001689 299040



29799 Mordillo, Wildlife

1000



4 001689 297992

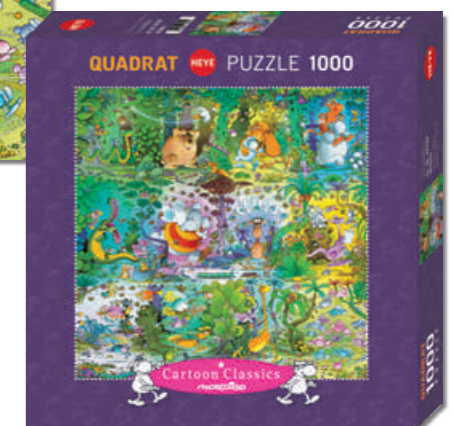



29820 Degano, Protest!

2000

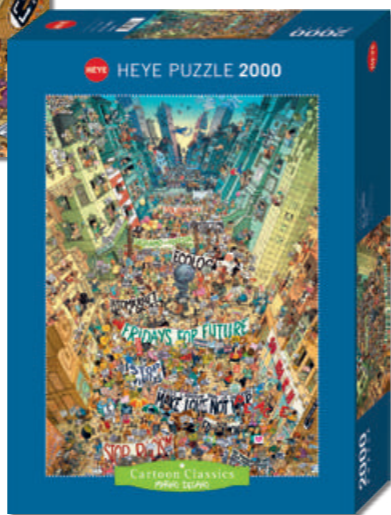

29873 Blachon, 4 Seasons



2000









DIE DREIECKSBOX

AUSSERGEWÖHNLICH – DEKORATIV – EXKLUSIV



-  Hochwertiges Poster inklusive!
-  High quality poster included!



-  Motivausschnitt auf der Oberseite für liegende Präsentationen!
-  Design detail on box top!
-  Vollständige Motivabbildung auf der Rückseite!
-  Complete puzzle design on the back of the box!
-  Alle wichtigen Informationen auf dem Boden gesammelt!
-  Detailed information on the box bottom!

TRIANGULAR BOX

EXTRAORDINARY – FANCY – EXCLUSIVE



NEW

29991 Tiurina, Home of Thoughts

1000



NEW

29990 Paul, Tree Lodges

1000



29993 Mitgutsch, Justice For All!

1000

NEW





NEW

29992 Degano, Insta-Girl's Life

1000

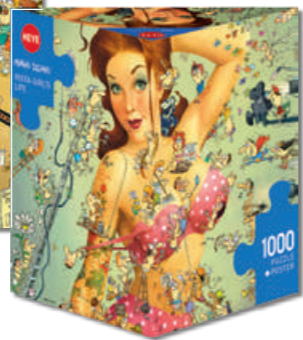

29932 Paul, Artist's Mind

1000



29927 Schöne, Hotel Life

1000



29933 Simon's Cat, Garden Adventures

1000





29922 Tanck, Seashore

1000

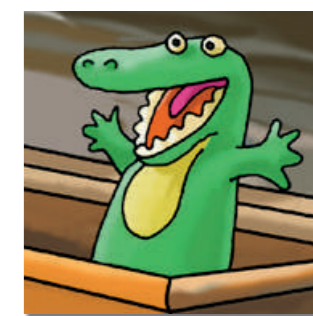

29885 Tanck, In The Attic

1000



29838 Tanck, Party Cats

1000

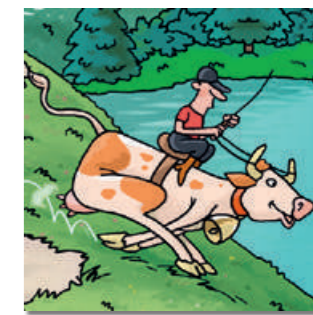

29680 Tanck, Alpine Fun

1000





Bestseller



29921 Degano, Elephant's Life

1000



4 001689 299217



29787 Degano, Flower's Life

1000



4 001689 297879

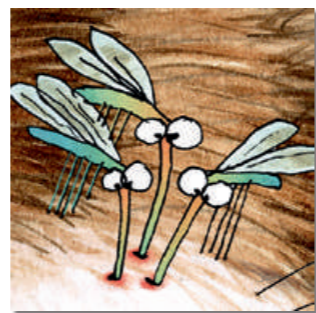

29569 Degano, Cat's Life

1000

10 Jubiläum Anniversary



4 001689 295691



29491 Degano, Dog's Life

1000



4 001689 294915





8793 Degano, Black or White



1000



29884 Göbel & Knorr, Market Place



Bestseller

1000



29920 Ruyer, Bunny Battles



1000



29888 Blachon, Cycle Race



1000

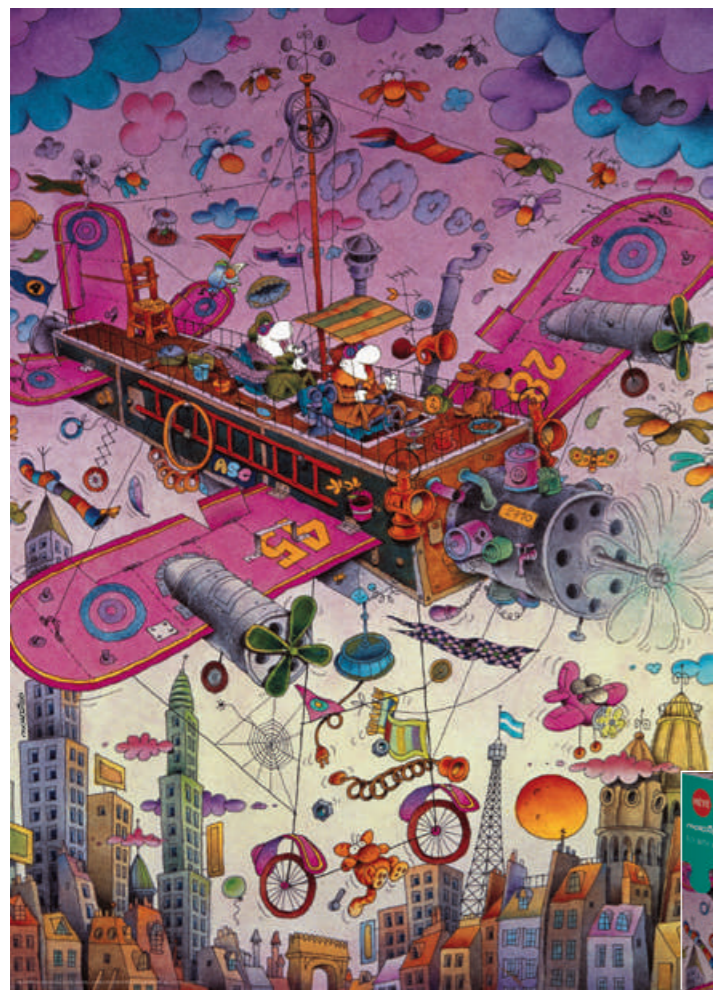

29887 Mordillo, Fly With Me!



1000

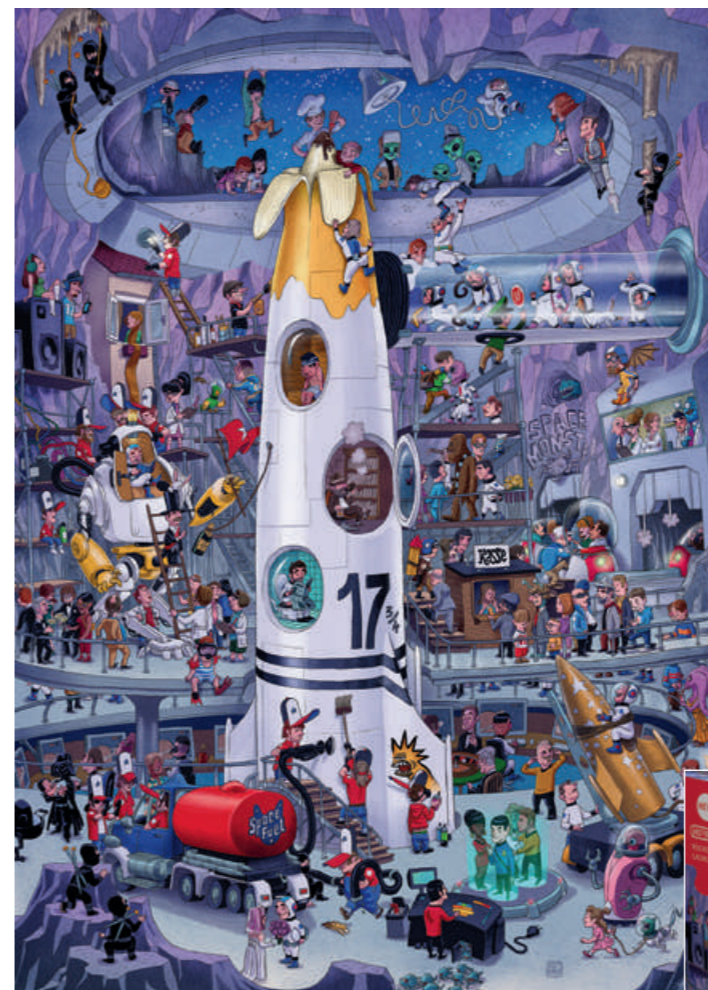

29790 Oesterle, Rocket Launch



1000



29839 Berman, Magic Sea



1000



29886 Oesterle, Gulliver



1000



29496 Ruyer, Bunnytown

1000

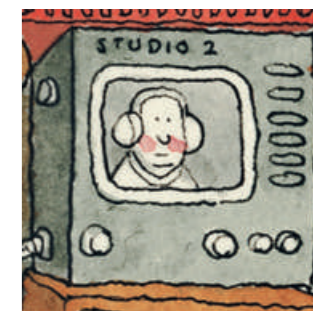
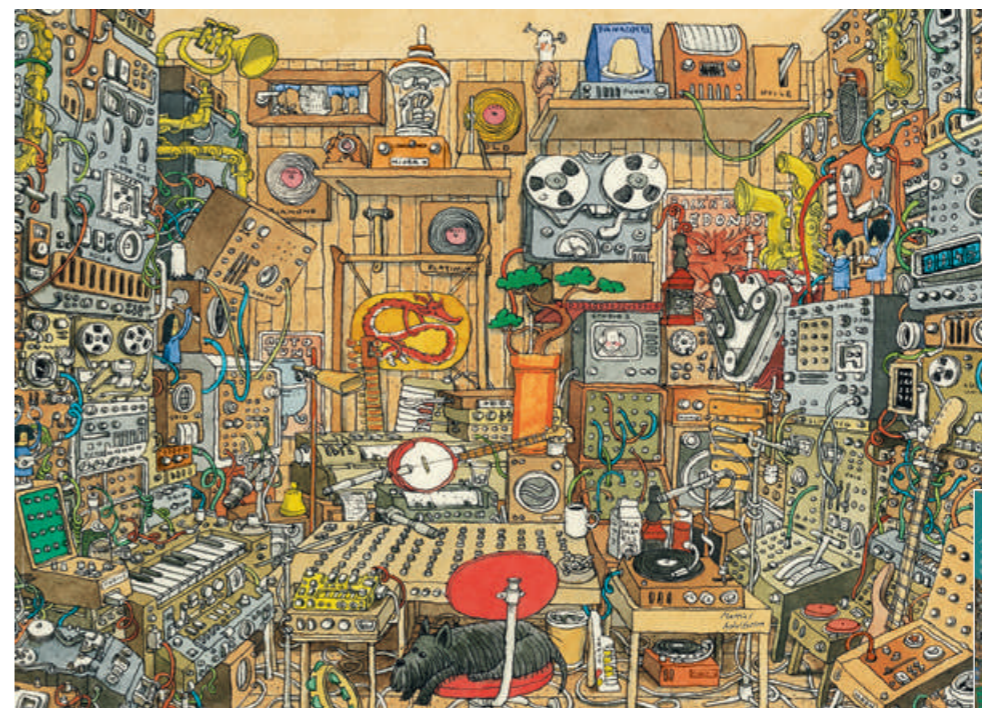

29928 Adolfsson, Music Maniac

1000

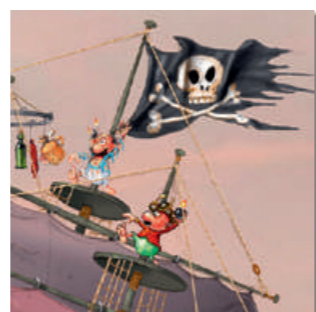

29570 Ruyer, Corsair

1000



Bestseller



29934 Oesterle, Chaotic Casino

1000





29995 Schöne, Hollywood

1500

NEW



29994 Tanck, Country Fair

1500

NEW



29929 Tiurina, Fun With Friends

1500



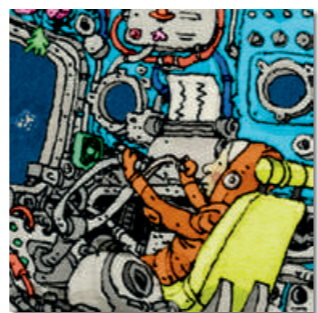

29841 Adolfsen, Spaceship

1500

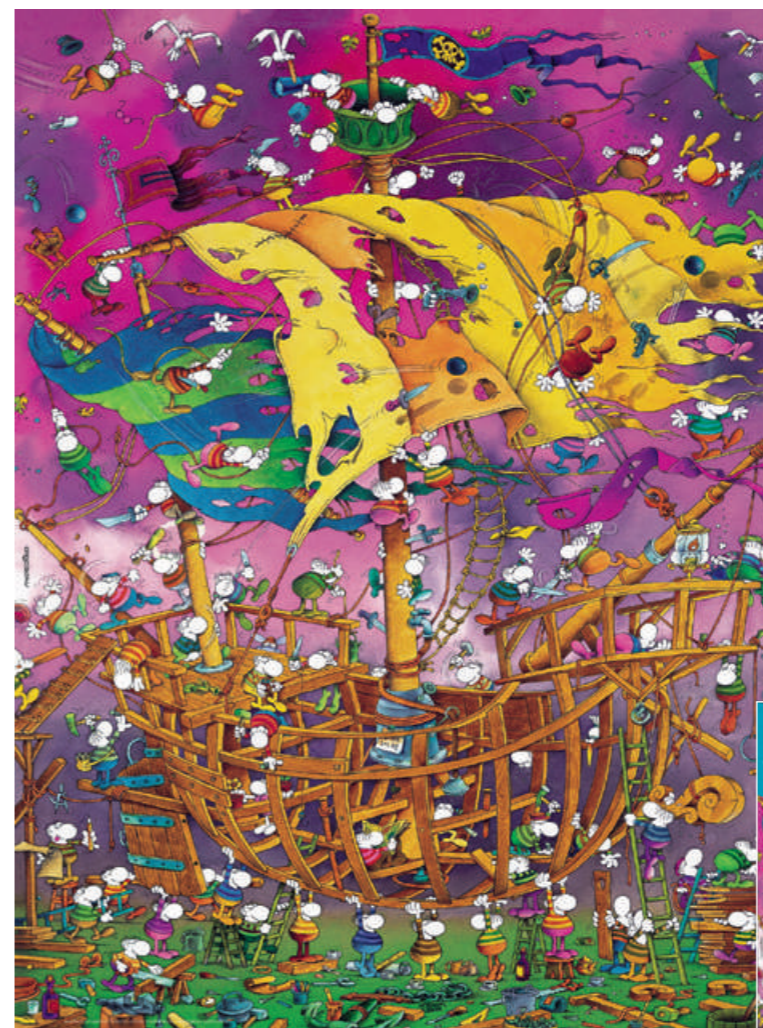

29924 Mordillo, Save The Ship!

1500



29891 Adolfsen, Regatta

1500



29925 Oesterle, Submarine Fun

1500





29793 Göbel & Knorr, Say Cheese!

Bestseller



1500



29744 Berman, Happytown

Bestseller



1500



29889 Berman, Patisserie



1500



29792 Berman, Wonderwoods



1500



29842 Schöne, Oktoberfest
1500

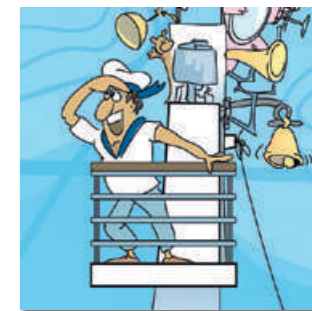

29697 Lyon, Cruise
1500



29130 Blachon, Bon Appétit!
1500



29840 Oesterle, Library
1500

Bestseller





Bestseller



29118 Prades, Heaven and Hell

1500



4 001689 291181



29890 Prades, History River

1500



4 001689 298906



29414 Prades, Fairy Tales

1500



4 001689 294144



29923 Loup, Monaco Classics

1500



4 001689 299231



29930 Berman, Go Camping!

2000



4 001689 299309



29996 Berman, Exotic Safari

2000

NEW



4 001689 299965



29931 Göbel & Knorr, Fashion Shoot

2000



4 001689 299316



29997 Göbel & Knorr, Superhero Movie

2000

NEW



4 001689 299972



29926 Göbel & Knorr, Street Parade

2000



4 001689 299262



29843 Göbel & Knorr, O Sole Mio!

2000

Bestseller



4 001689 298432



29730 Schöne, Train Station

2000



4 001689 297305



29753 Göbel & Knorr, Sherlock & Co.

2000

Bestseller



4 001689 297534



29577 Loup, Apocalypse

2000



10
Jubiläum
Anniversary



26127 Loup, Castle of Horror

2000



20
Jubiläum
Anniversary



25475 Loup, Arche Noah

2000



25784 Loup, Emergency Room

2000

Bestseller





29700 Ryba, Bavaria
2000



8660 Loup,
Orchestra
2000



Bestseller



29795 Ryba, Trafalgar
2000



29892 Ryba, Deep Jungle
2000



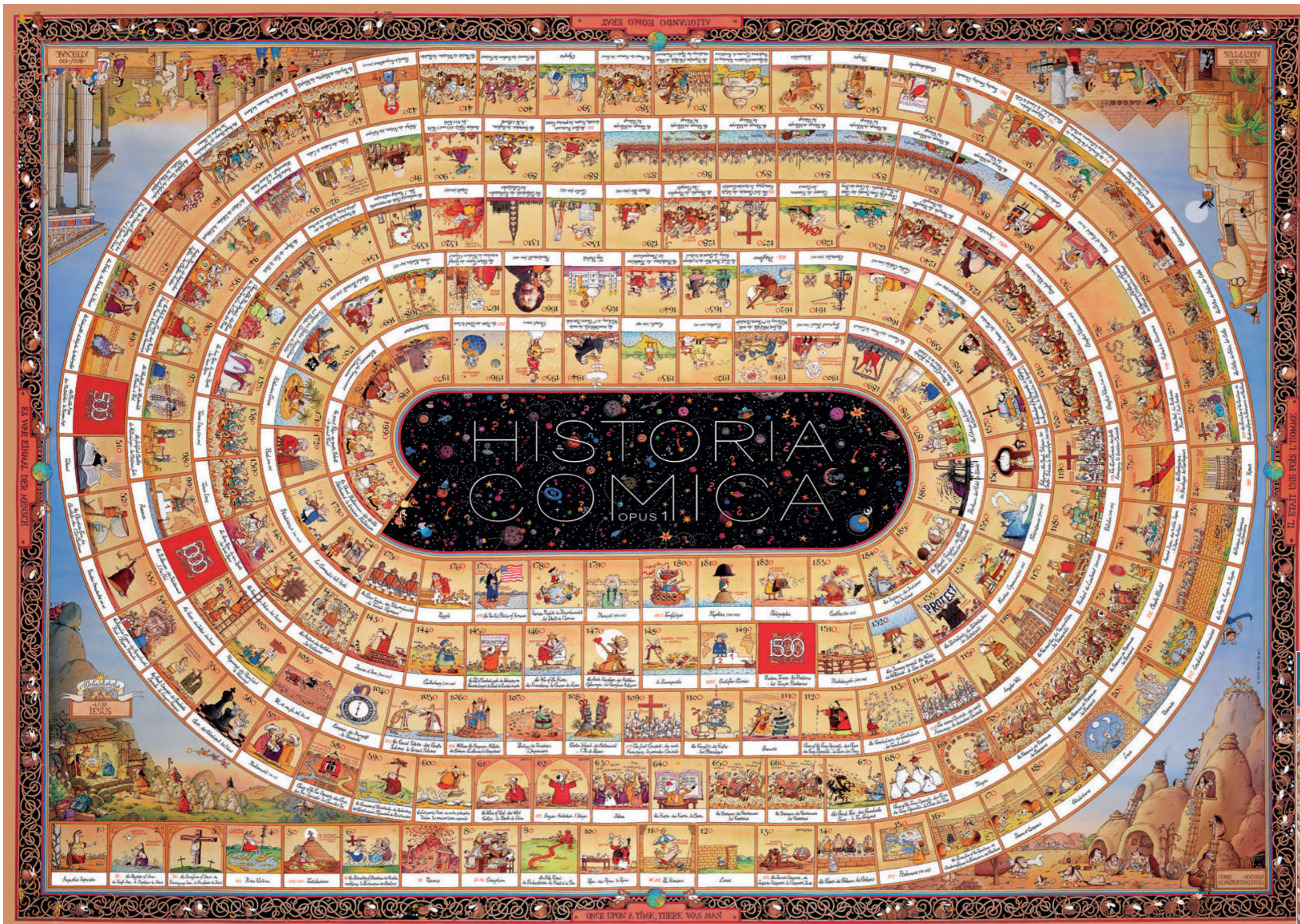

29341 Degano, Historia Comica – Opus 1

Bestseller

4000

4 001689 293413

TRIANGULAR

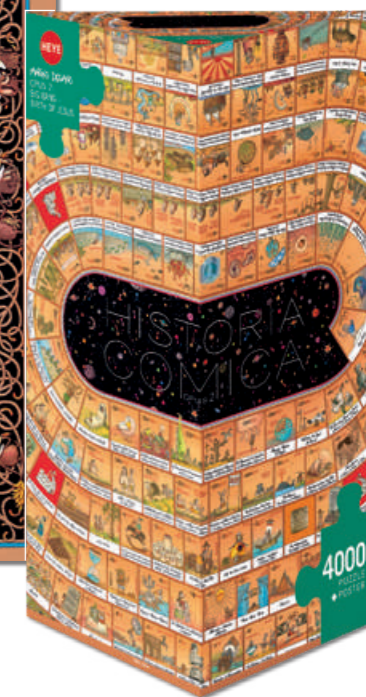

29342 Degano, Historia Comica – Opus 2

Bestseller

4000



TRIANGULAR



8854 Degano, United Dragons of Europe

4000

Bestseller



4 001689 088545

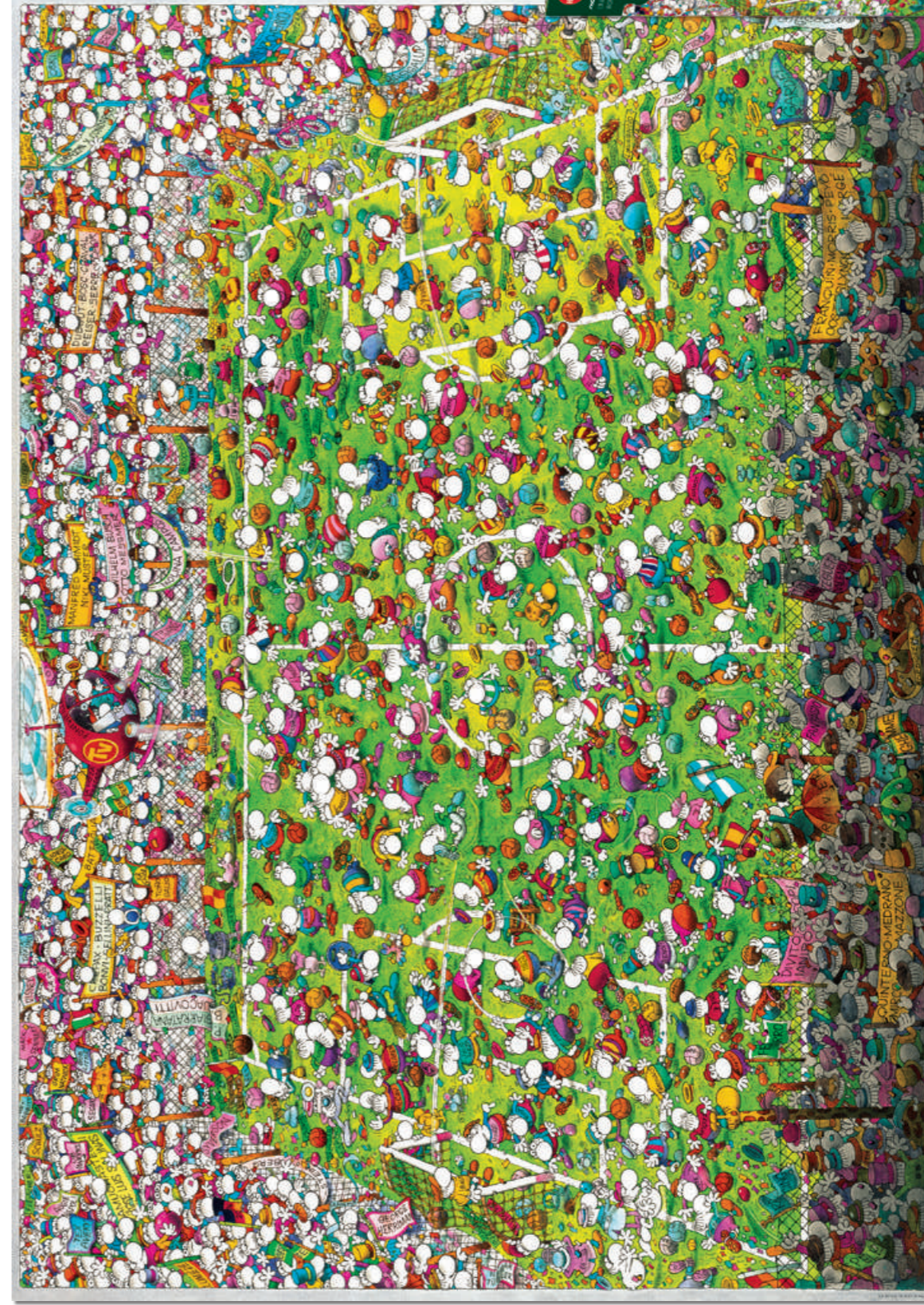

29072 Mordillo, Crazy World Cup

4000



4 001689 290726

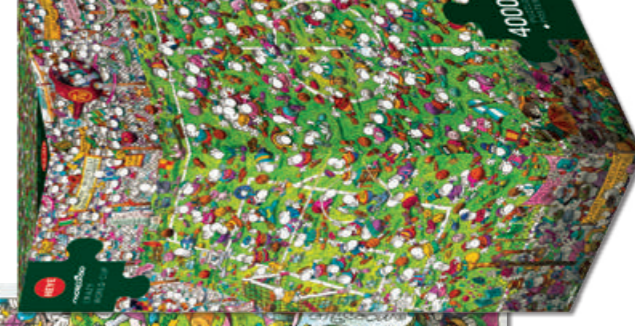



80590 Puzzle Sorter
6 Sortierboxen / sorting boxes



80588
Puzzle Conservers
ausreichend für
ein 1000-Teile-Puzzle /
sufficient for a
1000 pieces puzzle



70869
**Sortiment / Assortment
Puzzle Conservers**
Plano geliefert /
not assembled



80589
Puzzle Pad 2000
weiß / white, ca. 74 x 145 cm



80730
Puzzle Display
Dreieck / triangular



zur einfachen und dauerhaften Fixierung
des fertigen Puzzles

For easy and permanent fixing of the
finished puzzle

Zum sicheren Aufbewahren und Transportieren
angefangener und fertiger Puzzles

For safe storage and transport of started
and finished puzzles

Hochwertige Präsentation
der Dreieckspuzzles

- Platzsparendes Display für Dreiecks-
puzzles mit 16 x 1000 Teilen, 8 x 1500
Teilen und 8 x 2000 Teilen
- Höhe: 173 cm, Breite: 44 cm, Tiefe: 44 cm

Great point-of-sale presentation
of the triangular puzzles

- Space-saving display for 16 x 1000 pieces,
8 x 1500 pieces and 8 x 2000 pieces
triangular puzzles
- Height: 173 cm, width: 44 cm, depth: 44 cm





Puzzles		Teilezahl / no. of pieces	 A x B	 A x B x C
Standard	SPZ	500	ca. 35 x 50 cm	18.5 x 27.1 x 5.5 cm
	SPZ	1000	ca. 50 x 70 cm	27 x 37 x 5.4 cm
	SPZ	2000	ca. 68 x 96 cm	27 x 37 x 8.5 cm
	SPZ	3000	ca. 83 x 116 cm	27 x 37 x 8.5 cm
Vertical	VPZ	1000	ca. 32 x 94 cm	17 x 37 x 5.4 cm
Panorama / panoramic	PPZ	1000	ca. 94 x 32 cm	37 x 17 x 5.4 cm
	PPZ	2000	ca. 136 x 48 cm	37 x 17 x 8.5 cm
	PPZ	6000	ca. 235 x 83 cm	54.5 x 23 x 14 cm
Quadrat / square	QPZ	1000	ca. 56 x 56 cm	26.8 x 26.8 x 5.4 cm
Dreieck / triangular	DZp	1000	ca. 50 x 70 cm	27.2 x 27.7 x 14 cm
	DZp	1500	ca. 60 x 80 cm	27.2 x 35 x 14 cm
	DZp	2000	ca. 68 x 96 cm	27.2 x 42 x 14 cm
	DZp	4000	ca. 96 x 136 cm	27.2 x 49 x 14 cm





Zubehör / Accessories

Puzzle Conserver	-	5.5 x 13 x 3.5 cm
Sortiment / Assortment Puzzle Conserver	-	15.5 x 13.5 x 15 cm
Puzzle Pad	ca. 74 x 145 cm	17 x 46 x 9 cm
Puzzle Sorter	-	27.5 x 37.5 x 6 cm

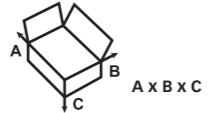
Display

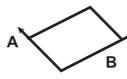
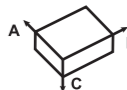
Puzzle-Display Dreieck / puzzle display triangular	44 x 173 x 44 cm	50 x 58 x 15 cm
--	------------------	-----------------

			
470 g	12	5.64 kg	38.6 x 36.6 x 28.6 cm
830 g	6	4.98 kg	38.6 x 36.6 x 28.6 cm
1320 g	4	5.28 kg	38.6 x 36.6 x 28.6 cm
1760 g	4	7.04 kg	38.6 x 36.6 x 28.6 cm
690 g	6	4.14 kg	38.6 x 36.6 x 18.6 cm
690 g	6	4.14 kg	38.6 x 36.6 x 18.6 cm
1280 g	4	5.12 kg	38.6 x 36.6 x 18.6 cm
3520 g	1	3.52 kg	59 x 28 x 17 cm
680 g	6	4.08 kg	38.8 x 28.1 x 28.1 cm
670 g	8	5.36 kg	63.5 x 22.5 x 44 cm
870 g	6	5.22 kg	63.5 x 22.5 x 44 cm
1200 g	6	7.20 kg	63.5 x 22.5 x 44 cm
2080 g	4	8.32 kg	63.5 x 22.5 x 44 cm

 Spielfläche /
puzzle size
 Schachtelformat /
puzzle box size
 Gewicht /
weight
 VSE im Karton /
pack quantity
 kg pro Karton /
kg per carton
 Größe des
Umkartons /
size of carton

Bestand, solange der Vorrat reicht. /
Subject to prior sales.

Aufgrund von Produktionsumstellungen
kann es innerhalb der Spielflächeabmes-
sung unserer Puzzles zu Abweichungen
kommen. /
As a result of production adjustments,
there may be deviations to the given
puzzle dimensions.

60 g	20	1.2 kg	25 x 22 x 20 cm
860 g	1	0.86 kg	29.5 x 26.5 x 22.5 cm
790 g	6	4.74 kg	49.5 x 37 x 30.5 cm
860 g	6	5.16 kg	38.5 x 35.5 x 29 cm
17 kg	1	17 kg	50 x 58 x 15 cm

General International Terms & Conditions of Athesia Kalenderverlag GmbH

valid as of December 1st, 2017, applicable to Puzzles

1. Conclusion of Contract

1.1: The awarding of the contract is solely subject to the seller's terms of sale and delivery, which are agreed upon for all present and future business transactions, when the buyer accepts the goods or the service at the latest.

They always override the buyer's conditions or conflicting confirmations to the contrary, even if the seller does not expressly revoke them.

1.2: Deviations from the seller's terms of sale and delivery as well as oral side agreements require the express written confirmation from the seller for each individual order to become effective.

2. Offers

2.1: The seller's offers are without engagement until accepted by the buyer.

2.2: Orders are binding for the buyer. Orders made by the buyer and received by the seller as well as offers, information and agreements from the seller's representatives shall become binding within three months after receipt of order with the written confirmation or execution of the order. The non-response of the seller to an order may not be understood as a refusal unless the buyer/orderer had expressly and clearly demanded confirmation.

2.3: **The minimum order is € 500.00.**

3. Prices

3.1: The price list valid at the time of placing the order shall apply. The prices included therein are the seller's sales prices ex works, expressed in Euro (€), net, with no cash discount or other discounts, without VAT and excluding delivery charges as per Item 4.

3.2: The respectively valid price list is drawn up new at the beginning of every calendar year; it thus replaces the price list that had been previously valid. Firm price agreements deviating from this are permitted and must be in writing.

3.3: If the time of ordering is uncertain, the current price list valid on the day of delivery shall apply.

4. Delivery

4.1: The goods are delivered ex works. The international Incoterms (2010) ex works (EXW) shall apply insofar as no other terms of delivery have been agreed upon.

4.2: The buyer is obliged to inspect the goods delivered immediately for transport damage. Should he determine such damage, the buyer is obliged to report the transport damage to the forwarding company immediately upon receipt and to have this confirmed. The seller may demand photos as evidence if in doubt. The buyer's right to claim defects to the products (Item 6) shall remain unaffected by this.

5. Delivery

5.1: All orders shall be executed subject to the seller's availability. The buyer agrees to a part delivery/part deliveries. This shall not release the seller from his further contractual obligation. Circumstances obstructing or impeding the delivery or the sales of the seller's goods as per contract and/or appears to jeopardize payment, shall cause the obligation to deliver and the obligation to provide advance payment to lapse. An obligation to deliver shall also lapse in the event of subsequent deliveries worth less than € 15.00.

5.2: Should the seller pass the agreed period of delivery, the customer shall still be obliged to accept the goods until a grace period of at least four weeks, set by the buyer in writing, has expired.

5.3: After the grace period has expired, the customer shall only have the right to withdraw from the contract, unless compensation can be claimed for intentional or grossly culpable non-compliance of the deadline.

5.4: The agreement upon a delivery date or date of performance does not constitute a firm commercial transaction.

6. Notice of defects and liability

6.1: The buyer is obliged to inspect the goods delivered in regard to the properties agreed upon. Recognisable product defects which are not due to damage during transportation (Item 4) must be notified of in writing within one week after delivery at the customer's but within six working days at the latest. After this period has expired, the notification of recognisable defects is excluded.

6.2: Claims for compensation of any kind against the seller are excluded unless the damage is due to intentional or gross culpable behaviour of the seller or the seller's representatives or vicarious agents or if the assured properties of the goods are lacking.

6.3: The exclusion of liability as per 6.2 does not apply if the claim for compensation results from a breach of an essential contractual obligation. Obligations essential for the contract are, in particular, those which, when being breached, endanger the purpose of the contract. Insofar as an obligation essential to the contract has been breached negligently, the obligation to pay compensation is limited to the typically foreseeable damage.

6.4: Liability in the event of damage from the injury to the life, body or health as well as liability as per the German Product Liability Act as of 15.12.1989 shall remain unaffected.

7. Payments

7.1: For first orders and unless otherwise agreed the seller's invoices are payable in advance upon placing the order. All other invoices are due 60 days after date of invoice net, unless otherwise agreed. Payments shall be made via (international) bank transfer. Cheques or bills of exchange shall not be accepted.

7.2: Deviating terms of payment must be agreed upon in writing in each individual case prior to collection or delivery of the goods.

7.3: The buyer may only charge against the claim for payment of the purchase price if the counter-claim is indisputable or determined without any further legal recourse. The buyer only has the right of retention for reasons of claims from the same contractual relationship.

7.4: In the event of several demands by the seller from different individual deliveries, and if the buyer is in arrears with the payment of one due invoice, the seller has the right to make the other invoices immediately payable, regardless of the later maturity of those invoices.

8. Retention of the title

8.1: **The goods shall remain the property of the seller until the respective delivery has been paid for in full.**

8.2: During the period of the retention of the title, the buyer is obliged to inform the seller without delay of garnishments, damage and decay of the goods delivered for the purpose of exercising his title.

8.3: If the buyer purchases the sales item for reselling purposes, the proceeds shall take the place of the sales items. The buyer's claims towards his customers shall be surrendered to the seller to the amount owed to him.

8.4: In the event of executing the retention of title, the buyer shall only have the right to the credit of the proceeds of the free-handed sale of the sales item.

8.5: In the event of default in payment, the buyer shall lose the right to the title and use of the item of purchase.

9. The provision of sales aids on loan

9.1: The sales aids provided to the buyer for free shall remain the seller's property. The seller reserves the right to confiscate the sales aids in all events. In the event of damage or loss, the seller is entitled to invoice the buyer for the sales aids provided.

9.2: The goods display is solely for the presentation of the seller's products.

10. Copyright; trademark rights

All products supplied by the seller are subject to statutory copyrights and trademark rights. Copies, reproductions, duplications irrespective of the type as well as the further use of parts of the products for commercial purposes is only permitted with the seller's written consent. The right to distribute illustrations of the products to promote sales shall remain unaffected.

11. Place of fulfilment and court of jurisdiction

11.1: Place of fulfilment for all mutual claims from the contractual relationship is Munich.

11.2: Court of jurisdiction for all disputes between the buyer and the seller, also for the conclusion of the contract, is Munich.

12. Applicable law; Ineffectiveness of individual provisions

13.1: The contract is subject to German law only.

13.2: The respective valid terms of sale and delivery of the Athesia Kalenderverlag GmbH shall apply upon conclusion of the contract. The seller is not obliged to expressly point out changes.

13.3: Should individual provisions of the afore-mentioned terms be or become ineffective in whole or in part, the effectiveness of the remaining provisions shall remain unaffected.

ATHESIA
UNTERNEHMENSGRUPPE

Your international contact

Athesia Kalenderverlag GmbH

Ottobrunner Straße 41
D-82008 Unterhaching
P.O. Box 14 80
D-82004 Unterhaching

www.athesia-verlag.de

Anne Kolehmainen

Phone: +49 (0)89 / 69 33 78 122

Fax: +49 (0)89 / 69 33 78 259

anne.kolehmainen@athesia-verlag.de

Wida Dimitrijevic

Phone: +49 (0)89 / 69 33 78 121

Fax: +49 (0)89 / 69 33 78 259

wida.dimitrijevic@athesia-verlag.de

Impressum

© 2021 Athesia Kalenderverlag GmbH
München – Unterhaching

Stand: Oktober 2021

Es gelten die allgemeinen Verkaufs- und Lieferbedingungen der Athesia Kalenderverlag GmbH. Erhältlich unter www.athesia-verlag.de oder beim Athesia Kundenservice.

Änderungen in Preis, Erscheinungstermin, Ausstattung und Layout der abgebildeten Produkte sowie Nichterscheinen abgebildeter Artikel bleiben vorbehalten.

All products shown are subject to change without notice in price, content, layout and availability.



Athesia Kalenderverlag GmbH
Ottobrunner Str. 41
D-82008 Unterhaching
Postfach 14 80
D-82004 Unterhaching

tel + 49 (0) 89/69 33 78-0
fax+ 49 (0) 89/69 33 78-139
www.athesia-verlag.de

Handelsregister:
HRB 173368
Verkehrsnummer: 16 493
UST-IdNr.: DE 260 320 723
GLN 40 01689 00000 4



Athesia Kalenderverlag GmbH

Ottobrunner Str. 41
D-82008 Unterhaching

Postfach 1480
D-82004 Unterhaching

Tel.: +49 (0) 89 / 69 33 78 100
Fax: +49 (0) 89 / 69 33 78 159

www.hey-puzzle.de
www.hey-puzzle.com
www.athesia-verlag.de

Follow us:



Art.-Nr. 80313-60